

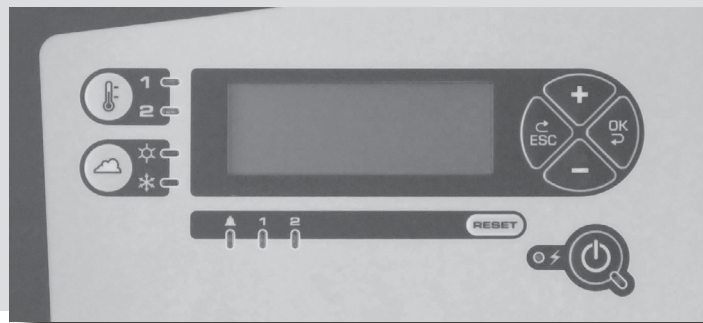

United Technologies

## CONTROLS MANUAL



Chiller - Heat Pump Control

**30WI**



<b>CONTENTS</b>	<b>PAGE</b>
<b>1 IMPORTANT RECOMMENDATIONS</b>	<b>3</b>
<b>2 GENERAL</b>	<b>3</b>
<b>3 COMPOSITION</b>	<b>4</b>
3.1 Main control board for machines with one refrigerating circuit	4
3.2 Additional board 1	5
3.3 Additional board 2	6
3.4 Control and display console	7
3.5 Connection via RS485 serial port for CMS or control console and Multi controller unit with 500 kW	8
3.6 Relay boards	9
<b>4 DESCRIPTION</b>	<b>9</b>
4.1 Main board	9
4.2 Expansion (additional) boards 1 and 2	9
4.3 Man-Machine Communication	10
<b>5 ACCESS LEVELS</b>	<b>10</b>
5.1 Selecting an authorised access level	10
5.2 Accessing the various access levels	10
5.3 Configuring access levels on the controller	11
5.4 Management of the numeric codes for accessing levels 2 and 3	11
5.5 Classification of the menus and their functions	11
<b>6 LIST OF PARAMETERS</b>	<b>12</b>
<b>7 MANAGEMENT OF THE DRYCOOLER controller parameters</b>	<b>20</b>
<b>8 CONTENTS OF THE MENUS</b>	<b>21</b>
8.1 MAIN menu	21
8.2 SETPOINTS menu	21
8.3 MACHINE STATUS menu	21
8.4 MEASURED VALUES menu	26
8.5 MACHINE PARAMETERS menu	26
8.6 ADJUSTMENT PARAMETERS menu	31
8.7 OPERATION PARAMETERS menu	39
8.8 FAULT MEMORY menu	50
8.9 TEST MODE menu	51
<b>9 MANAGEMENT OF THE ON/OFF INPUTS</b>	<b>52</b>
9.1 Automatic machine operation control	52
9.2 Load shedding control	52
9.3 Water flow switch	52
9.4 Fan fault (circuits 1 and 2)	53
9.5 Expansion valve fault	53
9.6 Phase controller fault	54
9.7 Pump fault	54
9.8 Compressor protection	55
9.9 Manual HP pressure switch fault on circuit 1 or 2	55
9.10 Setpoint selection via on/off input	56
9.11 Variable setpoint via 4-20 mA input	56
9.12 Operating mode selection	57
<b>10 MANAGEMENT OF THE ANALOGUE INPUTS</b>	<b>57</b>
10.1 Temperature sensor	57
10.2 Pressure sensor	60
<b>11 MANAGEMENT OF THE WATER PUMPS</b>	<b>61</b>
11.1 Pump 1	61
11.2 Pump 2	61
11.3 Pump management if P2 = 3 (reversible air-to-water) + heating mode + P111 = boiler	61
11.4 Unseizing and switching the pumps	61
<b>12 WINTER PROTECTION</b>	<b>61</b>
12.1 Frost protection of pumps and heat exchangers while unit is off:	61
12.2 Water loop winter protection	62
<b>13 MANAGEMENT OF THE FUNCTIONS</b>	<b>62</b>
13.1 Management of the compressor protections	62
13.2 Management of the time counters	63
13.3 Management of compressor start-up	63
13.4 Compressor stopping sequence	64
13.5 Management of the reversing valves	64
13.6 Management of configurable output P111:	64
<b>14 SELF-ADJUSTING FUNCTIONS</b>	<b>64</b>
14.1 Self-adjusting function: water frost limit	64
14.2 Self-adjusting function: refrigerant frost limit	64

<b>CONTENTS</b>	<b>PAGE</b>
14.3 Self-adjusting function: HP pressure limit	65
14.4 Self-adjusting function: discharge protection, circuit 1 or 2	65
14.5 Self-adjusting function: minimum HP, circuit 1 or 2	65
14.6 Self-adjusting function for high water return temperatures	65
<b>15 FAULT FUNCTIONS</b>	<b>65</b>
15.1 Water frost limit fault on circuits 1 and 2	65
15.2 Refrigerant frost limit fault on circuits 1 and 2	66
15.3 HP pressure fault, circuits 1 and 2	66
15.4 Discharge temperature fault, circuit 1 or 2	67
15.5 LP fault on circuit 1 or 2	67
15.6 Management of superheat faults	68
<b>16 CONTROLS</b>	<b>69</b>
16.1 Main control in cooling and heating modes (Operating mode based on P119)	69
16.2 Water temperature setpoint adjustment	70
16.3 Adjustment of water temperature setpoint if P7 ≠ INVERTER	70
16.4 Adjustment of setpoint for the water supply and return temperatures (P141 = 1 or 2) if P7 = INVERTER	73
16.5 Storage control	74
16.6 Control setpoint (P251) management	74
16.7 Automated self-regulating control	75
16.8 Control for bus connection to the Drycooler controller in FREECOOLING mode	75
<b>17 CONTROL OF CONDENSING PRESSURE FOR AIR-COOLED UNITS</b>	<b>75</b>
17.1 Control during normal operation or on/off control	75
17.2 Forced and self-adjusting control for A, B and C	77
17.3 Fan speed control	77
17.4 Low Noise control (single-fan units only)	80
17.5 Total recovery control	80
17.6 Management of the air blades if P10 = Centrifugal	81
<b>18 CONTROL OF CONDENSING PRESSURE FOR WATER-TO-WATER UNITS</b>	<b>82</b>
<b>19 RESTRICTION OF OPERATION OF THE MACHINES BASED ON THE OUTDOOR TEMPERATURE</b>	<b>82</b>
19.1 Restriction to the minimum air temperature in heating mode	82
19.2 Restriction to the maximum air temperature in cooling mode	82
19.3 Restriction to the maximum air temperature in heating mode	83
19.4 Restriction to the minimum air temperature in cooling mode	83
<b>20 MANAGEMENT OF THE AUXILIARY HEATER BOARD AND THE ELECTRIC AUXILIARY HEATERS</b>	<b>84</b>
<b>21 MANAGEMENT OF THE BACK-UP BOILER</b>	<b>85</b>
<b>22 MASTER/SLAVE CONTROL</b>	<b>85</b>
22.1 Case of two parallel-connected machines	85
<b>23 ACTUATION OF THE ELECTRONIC EXPANSION VALVE</b>	<b>89</b>
23.1 With Alco driver and display	89
23.2 With VCM driver	89
<b>24 IMPORTANT INFORMATION REGARDING THE CONTROL OF AN INVERTER COMPRESSOR</b>	<b>91</b>
<b>25 DEFROSTING OF THE EVAPORATOR COILS</b>	<b>92</b>
<b>26 HOURLY PROGRAMMING</b>	<b>92</b>
26.1 Presentation	92
26.2 Definition of the programming stages	93
26.3 Definition of holiday zones	93
26.4 Operation	93
<b>27 MANAGEMENT OF A REFRIGERANT FLUID LEAK DETECTOR:</b>	<b>95</b>
27.1 Link between the CAREL detector and the controller	95
27.2 Management of faults when a leak is detected by the CAREL unit	96
27.3 Management of faults if communication (bus) with the CAREL unit is lost	96
27.4 Management of sensor faults in the detector	96
27.5 Reading parameters	96
<b>28 MANAGEMENT OF ELECTRICAL POWER</b>	<b>97</b>
28.1 Management of load shedding on a power input threshold	97
28.2 Reading parameters	98
28.3 Display in the Measured values and Machine status menus	98
<b>29 MANAGEMENT OF MAINTENANCE REMINDER DISPLAY</b>	<b>98</b>
29.1 FGAS tightness check reminder	99
29.2 Maintenance reminder	99
29.3 Useful information for both functions	100
<b>30 COMMUNICATION PROTOCOL</b>	<b>101</b>
30.1 Registers accessible by customer	102
30.2 Customer access bits	103

## 1 IMPORTANT RECOMMENDATIONS

Your unit is equipped with a microprocessor-controlled electronic circuit board. To ensure the correct operation of your machine, you must follow the rules listed below.

### 1 Electrical power supply

Remote control: 230 V AC/50 Hz.

If the machine's remote control is powered separately (transformer not supplied), provide the following:

- 1 - A power supply line running **directly** from a distribution point (this line must be used **only** to supply power to the machine's remote control).
- 2 - This power supply line must be at least 1 metre away from all power lines (400 V).

### 2 Board controller specifications

Board power input: 35 Watts.

Maximum allowable voltage and current per input/output:  
253 V AC -3.15 A.

The board is powered by an onboard screw-on three-pin connector. The terminals are identified as follows:

- 1 - Live,
- 2 - Neutral,
- 3 - Earth.

Board fuse specifications:

Schurter UMT 250 V AC/3.15 A. Time lag: 10 x 3. Product code: 34031 0171.

Environmental conditions:

- In storage → -40/+80°C, 5/85% humidity without condensation.
  - In use → -20/+70°C, 5/85% humidity without condensation.
- Degree of pollution: 3.

### 3 Warning

Read the instructions in the manual before attempting to service the product.

Before attempting to service the board, disconnect its power source and make sure that no voltage is present.

To prevent the risk of electric shock, access to the board should be impossible while it is energised.

Certain parts of the board (USB and Ethernet connectors) may be hot. Based on the ambient temperature, they could cause burns. As a result, avoid touching these connectors while they are connected.

**Warning:**

**There is a risk of explosion if the battery is replaced by an incorrect type.**

Dispose of used batteries in accordance with local regulations.

### 4 Earthing

Compulsory (good earth quality in compliance with French standard NF C 15-100).

### 5 Connection of sensors

Keep connection cables away from power lines (400 V) or a remote control line (230 V). In the case of distances of over 6 m, use a shielded cable connected to the earth on the unit.  
Maximum distance: 25 m.

### 6 Connection of communication buses and of the remote console

#### 4-1 Connection cable specifications

- Flexible cable – RS 485 connection
- Two shielded wires
- Capacitance between cables and shield: 120 pF/m
- Resistance: 56 Ω/km

#### 4-2 Connection of the shield

- Connect the shield on the BMS or micro-computer end to earth.
- Ensure bonding all the way to the last unit (the shield on the communication cable must be connected between each unit).
- Do not connect the shield to the earth connection on the units.
- The wires exiting the shield must be as short as possible (2 cm) on each unit.

#### 4-3 Cable routing

- The cable must be at least 30 cm away from all 230 V or 400 V cables along its entire length.
- If a 230 V or 400 V cable must be crossed with a computer cable, they must cross each other at a right angle.

### 7 Connection of on/off inputs

#### •Distances of less than 30 metres:

- Use a shielded cable. Keep the cable at least 30 cm away from all lines that could generate interference. Connect the shield to the earth on the unit. If several shielded cables are used, connect each shield separately (if the risk of interference persists, install a relay for each input).

#### •Distances of greater than 30 metres:

- Install a relay for each input near the electronic circuit board (cable cross-section: 0.5 mm<sup>2</sup>)

#### •Example connection diagram:

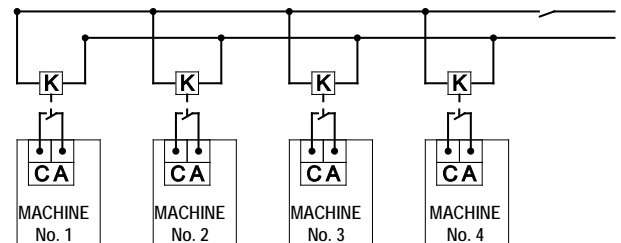

**K:** Auxiliary relay (fit near the electronic circuit board)

**CA:** Automatic operation control (on each machine)

## 2 GENERAL

This controller is fitted as standard on water chillers (or water heaters) equipped with one or two refrigerating circuits and scroll compressors. It is fitted on water-to-water, air-to-water and reversible air-to-water units.

Depending on the configuration, the board provides the following functions:

- ▶ Control of chilled water or hot water temperatures.
- ▶ Continuous monitoring of operating parameters.
- ▶ Diagnostics and fault storage.
- ▶ Setpoint drift based on the outdoor temperature (in heating and cooling modes).
- ▶ Communication with the console (remote or local) and the additional boards (fault reporting, BMS communication, Ethernet link for PC).

### 3 COMPOSITION

The controller consists of:

- ▶ One control and display panel fitted on the unit.
- ▶ One non-reversible circuit = one main board.
- ▶ One reversible circuit = one main board + one additional board (No. 1) → rotary switch in position 1.
- ▶ Two non-reversible circuits = one main board + one additional board (No. 2) two circuits → Rotary switch in position 1.
- ▶ Two reversible circuits = one main board + one additional board (No. 2) two circuits → Rotary switch in position 1.
- + one additional board (No. 2), two circuit changeover → Rotary switch in position 2.
- ▶ One auxiliary electric heater control board = additional board 1 → Rotary switch in position 2 (optional, ILD range).
- ▶ One remote console (optional).
- ▶ One relay board for operating states and faults (optional).

#### 3.1 Main control board for machines with one non-reversible refrigerating circuit

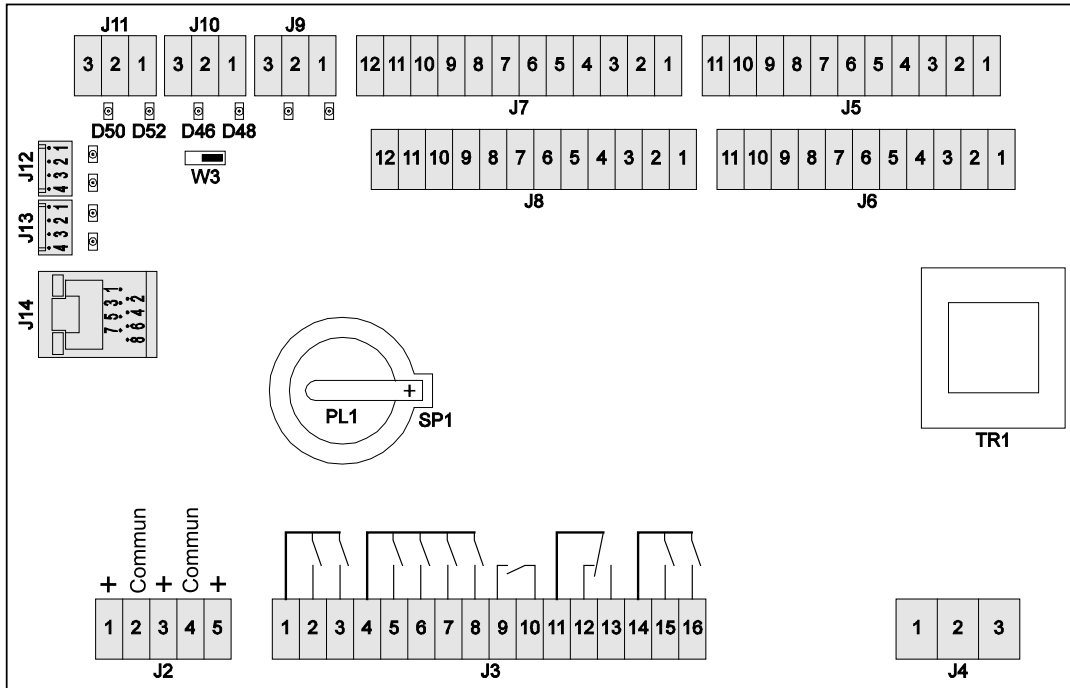

#### SWITCH W3

End-of-line resistance for two-wire RS-485 link. The switch must be turned to the left for the last unit on the loop and to the right for the others.

#### TERMINAL BLOCK J2 (analogue outputs)

1-2 0-10 V output 1 two-way valve or three-way valve if unit type (P2) = water-to-water.

or circuit 1 fan speed if unit type (P2) = air-to-water  
or reversible air-to-water when P10 = centrifugal.  
or air damper control if unit type (P2) = air-to-water  
or reversible air-to-water when P10 = centrifugal and P20 = yes.

3-4 0-10 V output 2 (Compressor INVERTER if P7 = INVERTER)  
4-5 0-10 V output 3 (variable speed pumps).

#### TERMINAL BLOCK J3 (on/off inputs)

- 1 Stage control common
- 2 Stage 1, circuit 1 control
- 3 Stage 2, circuit 1 control
- or if P7 = INVERTER (compressor shut off order to driver)
- 4 Common for fans, heater and heat trace cable
- 5 Circuit 1, fan 1 control
- 6 Circuit 1, fan 2 control
- 7 Heater control
- 8 Heat trace cable control
- 9-10 Configurable control based on P111:
  - Max. power
  - Boiler
  - Cooling/Heating
- 11 Fault output common
- 12 NC contact for fault output
- 13 NO contact for fault output
- 14 Common for pumps
- 15 Pump 1 control
- 16 Pump 2 or reversing valve control, circuit 1

#### TERMINAL BLOCK J4 (power supply)

- 1 230 V board power supply - Line
- 2 230 V board power supply - Neutral
- 3 Earth

#### TERMINAL BLOCK J5 (on/off inputs)

- 1-2 Motor fault, stage 1, circuit 1
- 2-3 Motor fault, stage 2, circuit 1
- 4-5 Manual reset fault, HP, circuit 1
- 5-6 Expansion valve fault, circuit 1
- 7-8 Phase controller fault
- 8-9 Water flow fault
- 10-11 Pump 1 fault

#### TERMINAL BLOCK J6 (on/off inputs)

- 1-3 Pump 2 fault
- 2-3 Automatic operation control
- 4-6 Setpoint 1/setpoint 2 selection
- 5-6 Heating/cooling selection if unit type (P2) = water-to-water  
or fan fault if unit type (P2) = air-to-water  
or reversible air-to-water
- 7-9 Stage 1, circuit 1 load shedding control
- 8-9 Stage 2, circuit 1 load shedding control
- 10-11 Recovery control

#### TERMINAL BLOCK J7 (analogue inputs)

- 1-2 10 K outdoor temperature sensor
- 2-3 10 K water inlet temperature sensor, heat exchanger 1
- 4-5 10 K water outlet temperature sensor, heat exchanger 1
- 5-6 10 K hot water temperature sensor if unit type (P2) = water-to-water  
or exchanger amb. temp. if unit type (P2) = air-to-water  
or reversible air-to-water
- 7 +24 V power supply for pressure sensors
- 8 0-10 V input for water inlet sensor on circuit 1
- 9 0-10 V input for water outlet sensor on circuit 1
- 10 Common for pressure sensors
- 11 4-20 mA remote setpoint
- 12 Setpoint common

**TERMINAL BLOCK J8** (analogue inputs)  
 1-2 Refrigerant temperature sensor, circuit 1  
 2-3 10 K suction temperature sensor, circuit 1  
 4-5 10 K liquid temperature sensor, circuit 1  
 6-7 50 K discharge temperature sensor, stage 1, circuit 1  
 7-8 50 K discharge temperature sensor, stage 2, circuit 1  
 9 +5 V power supply for pressure sensor  
 10 0-5 V input - HP sensor  
 11 0-5 V input - LP sensor  
 12 Common for pressure sensors

**TERMINAL BLOCK J9**  
 Bus connection for chiller or MULTI controller unit

**TERMINAL BLOCK J10**  
 Remote control console, relay board bus connection – Drycooler controller

**TERMINAL BLOCK J11**  
 BMS link

**TERMINAL BLOCK J12**  
 Local console link

**TERMINAL BLOCK J13**  
 Link for additional boards

**TERMINAL BLOCK J14**  
 Ethernet link for PC

**On/off input specifications: 24 V - 15 mA**

**On/off output specifications: 250 V - 2 A**

## 3.2 Additional board 1

### 3.2.1 Rotary switch set to position 1 - One circuit reversal use or recovery frost protection

**TERMINAL BLOCK J1**  
 Flash Memory connector

**TERMINAL BLOCK J2**  
 Link with motherboard or another additional board

**TERMINAL BLOCK J3**  
 Link with another additional board

**TERMINAL BLOCK J4** (on/off inputs)  
 1-2 Heating/cooling selection input if unit type (P2) = reversible air-to-water and number of circuits (P3) = 1  
 2-3 Available  
 4-5 Available

**TERMINAL BLOCK J5** (on/off inputs)  
 1 Common to all outputs  
 2 Circuit 1 reversing valve control  
 3 Circuit 1 pressure balance valve control  
 4 Recovery frost protection heat trace cable  
 5 Reverse rotation control for fans

**TERMINAL BLOCK J6** (analogue inputs)  
 1-2 Temperature sensor, coil A, circuit 1  
 2-3 Temperature sensor, coil B, circuit 1

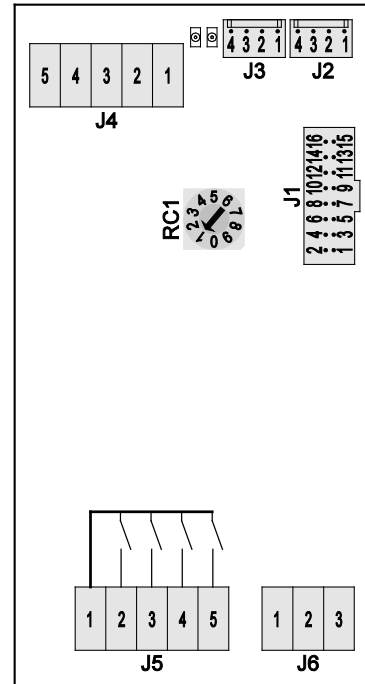

### 3.2.2 Rotary switch set to position 2 - Use of electric auxiliary heaters

**TERMINAL BLOCK J1**  
 Flash Memory connector

**TERMINAL BLOCK J2**  
 Link with motherboard or another additional board

**TERMINAL BLOCK J3**  
 Link with another additional board

**TERMINAL BLOCK J4** (on/off inputs)  
 1-2 Programmable input (P113)  
 2-3 Fault 1, electric stages  
 4-5 Fault 2, electric stages

**TERMINAL BLOCK J5** (on/off inputs)  
 1 Common to all outputs  
 2 Electric stage 1 output  
 3 Electric stage 2 output  
 4 Electric stage 3 output  
 5 Electric stage 4 output

**TERMINAL BLOCK J6** (analogue inputs)  
 1-2 Available  
 2-3 Available

### 3.3 Additional board 2

#### 3.3.1 Rotary switch set to position 1 - Two circuit use

##### TERMINAL BLOCK J1

Flash Memory connector

##### TERMINAL BLOCK J2 (on/off inputs)

- 1-2 Motor fault, stage 1, circuit 2
- 2-3 Motor fault, stage 2, circuit 2
- 4-5 Manual reset fault, HP, circuit 2
- 5-6 Expansion valve fault, circuit 2
- 7-8 Load shedding input, stage 1, circuit 2
- 8-9 Load shedding input, stage 2, circuit 2

##### TERMINAL BLOCK J3 (on/off inputs)

- 1 Common for stages 1 and 2, circuit 2
- 2 Stage 1, circuit 2 control
- 3 Stage 2, circuit 2 control
- 4 Common for fan stages
- 5 Stage 1, circuit 2 fan control
- 6 Stage 2, circuit 2 fan control
- 7 Stage 3, circuit 1 fan control if coil type (P11) = split  
or stage 1, common fan if coil type (P11) = mixed
- 8 Stage 3, circuit 2 fan control  
if coil type (P11) = split  
or stage 3, common fan if coil type (P11) = mixed

##### TERMINAL BLOCK J4 (analogue inputs)

- 1-2 10 K water outlet temperature sensor, heat exchanger 2
- 2-3 10 K manifold water outlet temperature sensor
- 4-5 10 k refrigerant temperature sensor, circuit 2
- 5-6 50 K Discharge temperature 3 or 2 if 2 circuits and 1 stage per circuit (P3 =1) (stage 1, circuit 2)
- 7-8 50 K sensor, discharge temperature 4 (stage 2, circuit 2)
- 8-9 Circuit 2 suction temperature
- J4-10, J5-1 Circuit 2 liquid temperature

##### TERMINAL BLOCK J5 (analogue inputs)

- 1 Common
- 2 Available
- 3 +5 V power supply for pressure sensors
- 4 0-5 V input for HP sensor on circuit 2
- 5 0-5 V input for LP sensor on circuit 2
- 6 0 V power supply, HP-LP pressure sensors
- 7 +24 V power supply for water pressure sensors
- 8 0-10 V input for water inlet circuit on exchanger 2
- 9 0-10 V input for water outlet circuit on exchanger 2
- 10 0 V power supply for water pressure sensors

#### 3.3.2 Rotary switch set to position 2 - Two circuit reversal use

##### TERMINAL BLOCK J1

Flash Memory connector

##### TERMINAL BLOCK J2 (on/off inputs)

- 1-2 Heating/cooling selection input if unit type (P2) = reversible air-to-water  
and number of circuits (P3) = 2
- 2-3 Available
- 4-5 Available
- 5-6 Available
- 7-8 Available
- 8-9 Available

##### TERMINAL BLOCK J3 (on/off inputs)

- 1 Common for reversing valves
- 2 Circuit 1 reversing valve control
- 3 Circuit 2 reversing valve control
- 4 Common for balance valves
- 5 Circuit 1 balance valve control
- 6 Circuit 2 balance valve control
- 7 Reverse rotation control for circuit 1 fans
- 8 Reverse rotation control for circuit 2 fans

##### TERMINAL BLOCK J4 (analogue inputs)

- 1-2 Temperature sensor, coil A, circuit 1
- 2-3 Temperature sensor, coil B, circuit 1
- 4-5 Temperature sensor, coil C, circuit 1
- 5-6 Temperature sensor, coil D, circuit 1
- 7-8 Temperature sensor, coil A, circuit 2
- 8-9 Temperature sensor, coil B, circuit 2

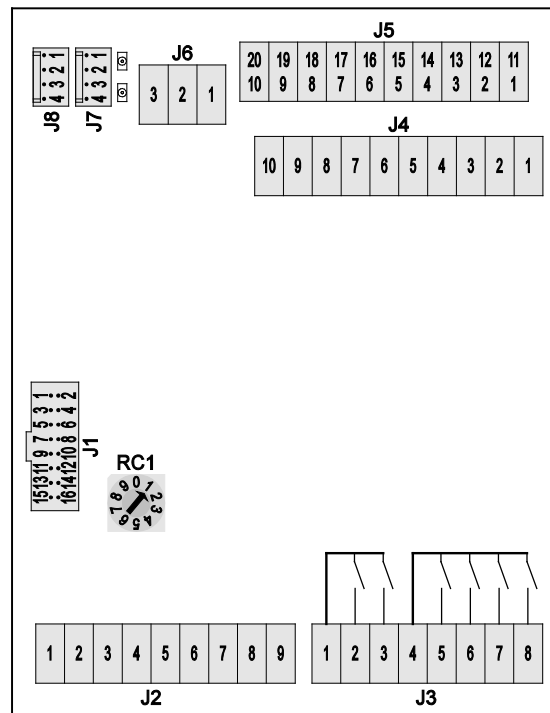

##### TERMINAL BLOCK J6 (analogue outputs)

- 1 0-10 V output for circuit 2 fan
- 2 Common for outputs
- 3 0-10 V output for common fan, circuits 1 and 2

##### TERMINAL BLOCK J7

Link with motherboard or another additional board

##### TERMINAL BLOCK J8

Link with another additional board

8-10 Temperature sensor, coil C, circuit 2

##### TERMINAL BLOCK J5 (analogue inputs)

- 1-2 Temperature sensor, coil D, circuit 2
- 3 +5 V power supply - Available
- 4 0-5 V input - Available
- 5 0-5 V input - Available
- 6 0 V power supply - Available
- 7 +24 V power supply - Available
- 8 0-10 V input - Available
- 9 0-10 V input - Available
- 10 0 V power supply - Available

##### TERMINAL BLOCK J6 (analogue outputs)

- 1 0-10 V output - Available
- 2 Common for 0-10 V output - Available
- 3 0-10 V output - Available

##### TERMINAL BLOCK J7

Link with motherboard or another additional board

##### TERMINAL BLOCK J8

Link with another additional board



### 3.4 Control and display console

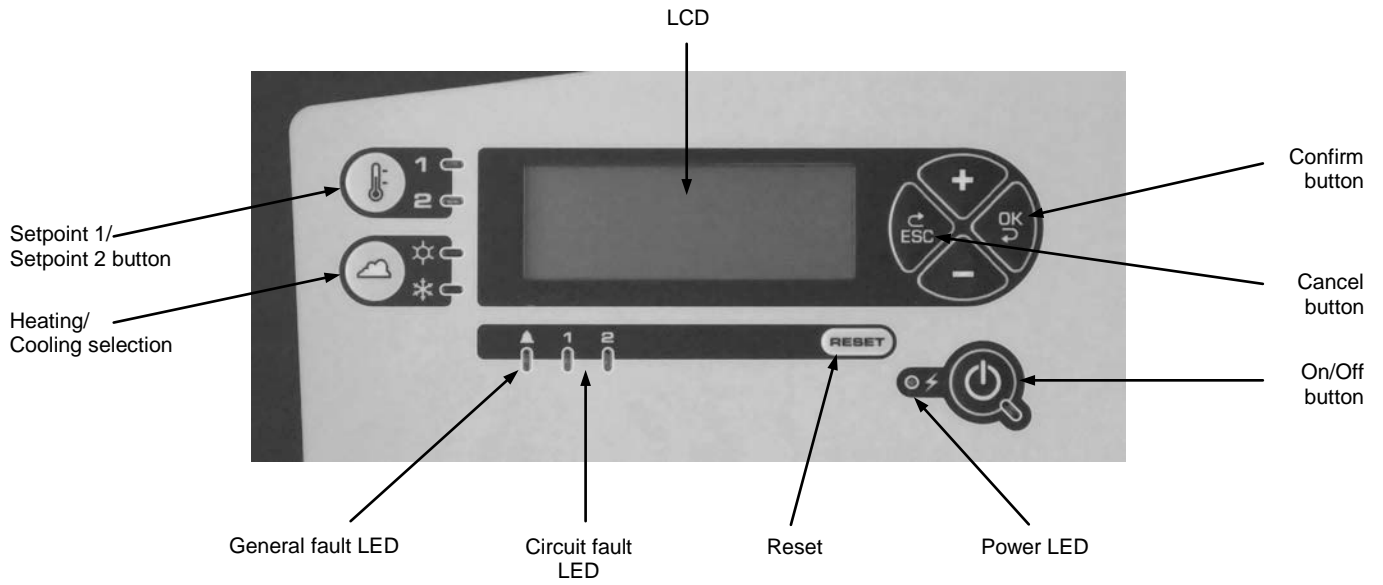

The local console and the remote control console have the same front.

Mounting dimensions (in mm) of remote control console

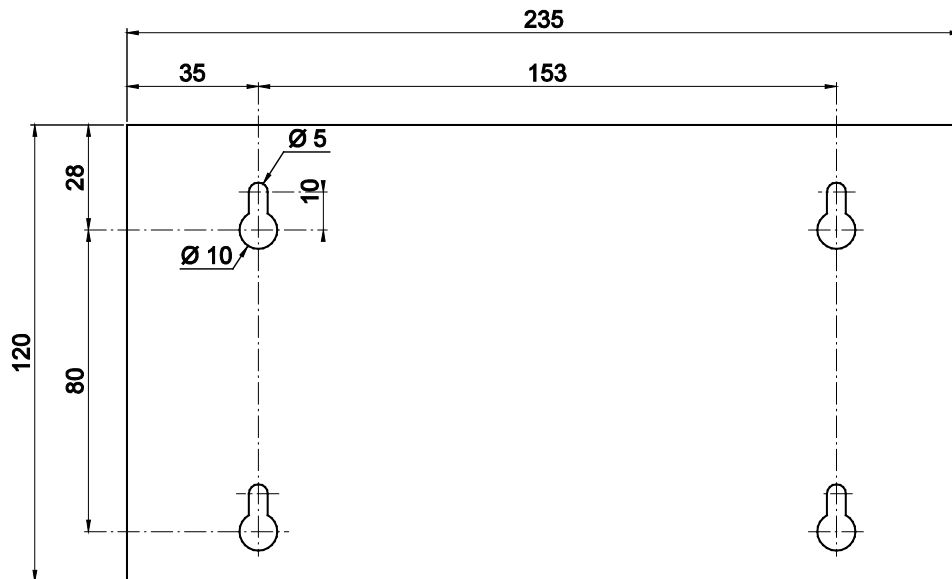

### 3.5 Connection via RS485 serial port for CMS or control console and Multi controller unit

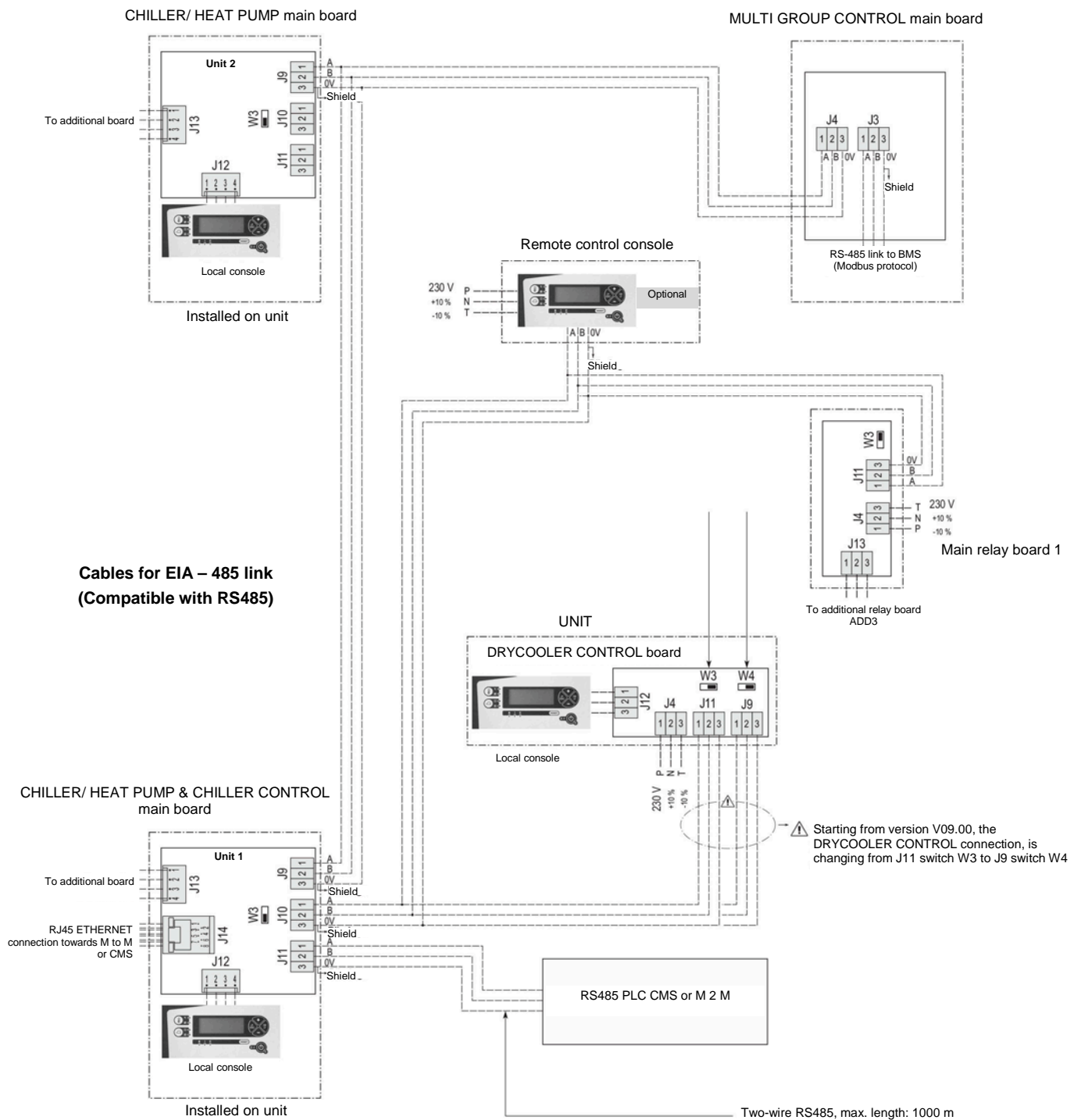

For connection to a CMS, refer to document 3991062

Identification of Modbus connection terminals

- 1 → A or +
- 2 → B or -
- 3 → Earth (shield)

### 3.6 Relay boards

The dry contacts on the relay boards make it possible to remotely view the states of the stages that are on and all the fault states on the unit. For more information, see document 3991061 provided in the KIT

## 4 DESCRIPTION

### 4.1 Main board

Main board for units with one non-reversible refrigerating circuit:

- **Analogue inputs:**

Acquire signals measured by temperature sensors.  
Acquire signals measured by pressure by sensors.

- **On/Off inputs:**

Acquire operating state signals from surrounding electromechanical components.

- **Actions:**

Comparison of setpoint and water temperature to calculate which stages are to be turned on or off.  
Management of the protections for the machine's self-adjusting operation.

- **Outputs:**

Control stage control.  
Pump control.  
General fault.

- **The board also features:**

- An "end-of-line resistance" switch.

### 4.2 Expansion (additional) boards 1 and 2

These boards are used for units with two reversible refrigerating circuits. They manage the inputs/outputs on the second circuit or required for reversing the circuits.

- **Analogue inputs:**

Acquire signals measured by temperature sensors.  
Acquire signals measured by pressure by sensors.

- **On/Off inputs:**

Acquire operating state signals from surrounding electromechanical components.

- **Outputs:**

Control stage control.

### 4.3 Man-Machine Communication

- **Local console:**

- The controls on the local console are enabled regardless of the value of P103.  
- Acknowledgment of faults is possible.

- **Remote control console:**

- All parameters may be read depending on the authorised access level.  
- All unit controls are enabled if P103 = remote or BMS.  
- In this case, the following parameters may be accessed for modification:  
- On/Off.  
- Cooling/Heating.  
- All adjustment parameters are locked, depending on the authorised access level, except for the first 11 if P103 = local.  
- Acknowledgment of faults is not possible.  
- Test mode is possible.

- **CMS:**

- All parameters (except P100, P103, P104 and P105) are accessible in read mode.  
- All parameters (except P1 to P99, P100, P103, P104 and P105) are accessible in write mode. However, access to parameters P1 to P99 is possible when P99 is unlocked on the machine's local console.  
- Acknowledgment of faults is not possible.

**NOTE:** All the registers (see communication protocol) appear regardless of the value of P103.

To enable write mode, P103 must be set to 'remote or BMS'.

To be able to switch between heating and cooling, P119 must be set to 'cooling/heating' via the console.

To be able to switch between setpoints 1 and 2, P120 must be set to '2' via the console.

#### Locking the console:

**⚠ Available only on the local console on the unit.**

The factory setting for the console is 'unlocked'.

The lock status is saved in the event of a mains power failure.

If lock mode is enabled while modifying a parameter, any modifications made are aborted and the controller is reset to its

initial value.

To lock the console, simultaneously hold down the + and – buttons for 5 seconds (possible in any menu on the console).

The following message appears on the screen for 5 seconds then machine state reappears.

C O N S O L E L O C K E D
------------------------------

All modifications from the local console are then inhibited.

Any attempts to make modifications will cause the above message to appear for 3 seconds.

To unlock the console, simultaneously hold down the + and - buttons for 5 seconds. The following message appears on the screen for 3 seconds:

```

C O N S O L E
U N L O C K E D

```

## 5 ACCESS LEVELS

The CHILLER/HEAT PUMP controller features three parameter access levels:

- Level 1: Users
- Level 2: Technicians/Maintenance
- Level 3: Manufacturer's technicians (full access)

### 5.1 Selecting an authorised access level

Authorised access levels are selected in menu 14 (ACC. LEVEL SELECT.). The following screen appears:

```

C O N T R O L L E R   I N   L E V E L   x
1 4 - 1   A C C E S S   T O   L E V E L   2
1 4 - 2   A C C E S S   T O   L E V E L   3

```

- Level 3 provides automatic access to all levels (Manufacturer's technicians).
- Level 2 provides access to levels 1 and 2 only (Technicians/Maintenance and Manufacturer's technicians).
- Level 1 provides access to level 1 only (all users).

### 5.2 Accessing the various access levels

#### 5.2.1 Restricting access to level 1 only

- Access level 2 is the default access level.
- If you are in a higher level and you want to restrict access to level 1 only, simultaneously hold down the **ESC** and **OK** buttons for 10 seconds.
- No password is needed to access level 1. The setpoint adjustment range is + or – 5 K lower than in the higher access levels.
- The restriction messages remain displayed in access level 1. Operating messages in optimised mode are visible only in access levels 2 and 3.
- Restriction of access to level 1 only is stored in memory in the event of a mains power failure.

#### 5.2.2 Access to level 2:

- A numeric code must be entered to access level 2:
- The following menu for entering this code appears when LEVEL 2 is selected:

```

L E V E L   2
A C C E S S   C O D E
* * * *

```

- Using the + and – buttons, replace this first symbol (\*) by the first character in the code and press **Enter**. Do the same for the second, third and fourth symbols. When the last character is entered and **Enter** is pressed, the following menu appears:

```

L E V E L   2
N E W   A C C E S S   C O D E
* * * *

```

- To select a new access code, proceed as described above. When the last character is entered and **Enter** is pressed, the screen displays the menu below followed by the main menu.

```

L E V E L   2
N E W   C O D E   S A V E D

```

- If you do not want to change the level 2 access code, press **ESC** to exit the new access code menu and go back to the main menu.
- If you have changed your access code but have forgotten it, you can reset it to the original code by entering the LEVEL 2 ACCESS CODE menu and simultaneously holding down the + and **Reset** buttons for 10 seconds.

### 5.2.3 Access to level 3

A non-modifiable numeric code must be entered to access level 3:

- The following menu for entering this code appears when LEVEL 3 is selected:

```
      L E V E L   3
    A C C E S S   C O D E
      * * * *
```

- Using the + and – buttons, replace this first symbol (\*) by the first character in the code and press **Enter**. Do the same for the second, third and fourth symbols. When the last character is entered and **Enter** is pressed, the main menu appears.

### 5.2.4 Restricting access from level 3 to level 2

To restrict access from level 3 to level 2 only, go to the following menu:

```
1 4 - 1   A C C E S S   T O   L E V E L   2
```

Press **Enter**. The following menu appears:

```
      A C C E S S   T O   L E V E L   2
    O N L Y
      Y E S / N O
```

To restrict the controller to access level 2, select 'Yes' and press **Enter**.

### 5.2.5 Displaying the access codes on the controller after incorrectly entering the access codes:

- The digits in the access codes are replaced by the\* symbol. When the + or - buttons are pressed, this symbol is replaced by the digit 0. The digits in the code can then be selected using the + or - buttons.

The \* symbol appears when the digit is confirmed by pressing **Enter**.

- The following message appears for 5 seconds if the access code is not entered correctly:

```
      W R O N G   C O D E
```

- When an access level is changed, the following message is displayed for 5 seconds:

```
      A C C E S S   L E V E L   x
```

## 5.3 Configuring access levels on the controller

- All three access levels on all the boards are accessible for a total of 20 hours of 'on' time after the controller is first turned on. During this period any defective boards may be removed and their replacement boards configured and checked to ensure correct operation of machine.

This time period will be automatically cancelled if a user switches to level 1 or level 2 before it ends.

When the time period ends, level 2 will be authorised unless the person commissioning the system chooses to restrict access by the end user to level 1.

- If access level 3 is authorised in order to adjust the machine parameters and, for indeterminate reasons, it is left accessible to all users, only level 2 access will be possible after a period of 4 hours.

- Commissioning of the machine can be prohibited simply by setting parameter P99 to 'No' in level 2.

**Only those with the level 2 access code may re-enable commissioning of the machine.**

## 5.4 Management of the numeric codes for accessing levels 2 and 3

- Access to level 3 is direct for anyone with a PC running the program needed to communicate with the chiller/heat pump controller and who connects to the board.

- Access to levels 2 and 3 is restricted to the *manufacturer's service technicians*. Please contact your local branch.

## 5.5 Classification of the menus and their functions

### Level 1:

➤ Menu:

Setpoint, machine status, measured values, control parameters, operation parameters, fault memory, hourly scheduling, communication and access level selection.

➤ Function:

all functions accessible via the console: On/Off, **Reset**, Heating/Cooling selection; Setpoint 1/2 selection

### Level 2:

➤ Menu:

all level 1 menus + test mode and master/slave operation

### Level 3:

➤ Menu:

all level 2 menus + electronic expansion valve

## 6 LIST OF PARAMETERS

**ACCESS LEVEL:** 1 = Access to **USER** parameters (level 1 parameters only)

2 = Access to visible and editable parameters (level 1 and 2 parameters). EDITABLE numeric code.

3 = Access to **Manufacturer's TECHNICIAN** parameters (level 1, 2 and 3 parameters). UNEDITABLE numeric code

Access level	No.	Description	Setting	Default	Display conditions
<b>CONFIGURATION OF THE MACHINE</b>					
3	1	Refrigerant type	R407C, R134a, R404a, R22, R410A	R410 A	
3	2	Unit type	1-Water-to-Water 2-Air-to-Water 3-Reversible air-to-water	2	
3	3	Number of circuits	1-2	1	
3	4	Number of stages on circuit 1	1 or 2	1	
3	5	Number of stages on circuit 2	0, 1, 2	0 if P3 = 1 1 if P3 = 2	Hidden if P3 = 1
3	6	Number of evaporators	1 if P3 = 1, 1 if P3 = 1 and P2 = air-to-water 2 if P3 = 2	1 if P3 = 1 2 if P3 = 2	
3	7	Compressor supplier	Maneurop - Copeland - Inverter	Copeland	
3	8	Heat exchanger suppliers	EXL - Swep - Swep double - Alfa laval	EXL	- If P03 = 1 and P06 = 1, then P08 = EXL or SWEP - If P03 = 2 and P06 = 2, then P08 = EXL or SWEP If P03 = 2 and P06 = 1, then P08 = ALFA LAVAL or SWEP DOUBLE
3	9	Stage 2 shut-down time delay	1 to 10 s	2 s	If P4 = 2
3	10	Fan type	Centrifugal - Propeller – Available pressure	Propeller	If P2 = 2, 3
3	11	Coil type	Intertwined - Split - Mixed	Intertwined	If P3 = 2, P10 = pressure , P2 = 2, 3
3	12	Pressure balance solenoid valve	No - Yes	No	If P2 = reversible air-to-water
3	13	Tandem type	Balanced Yes/No	Yes	
3	14	Number of coil sensors per circuit	1.2 or 4	1 if P3 (No. of circuits) = 1 2 if P3 = 2.	
2	15.1	Measurement of electrical value	Yes/No	No	
2	15.2	Electrical network type	1BL,2BL,3BL,4BL and 4NBL	3BL	If P15.1 = Yes
2	16	Primary CT rating	5 to 1000 A in increments of 1	400 A	If P15.1 = Yes
2	17	Secondary CT rating	1 or 5 A	5 A	If P15.1 = Yes
<b>OPTION</b>					
2	20	All-season operation	No - Yes	Yes	If P2 = 2, 3
2	21	Variable speed drive	1 - Without 2 - With acoustic optimisation 3 - With energy optimisation	Without	If P2 = 2, 3 P10 = Propeller Value 3 accessible only if P42 = VCM
2	22	Electric auxiliary heaters	No - Yes	No	If P2 = 1 or 3
2	25	Number of pumps delivered	0-1-2 if P2 = 2 and 0-1 if P2 = 3	0	Visible if P2 = 2 or 3
2	26	0-10 V configurable output	V2V - V3V	V2V	2WV, Visible if P2 = water/water and P3 = 1 3WV, Visible if P2 = water/water
2	27	Pump controlled by operation of boiler	Yes/No	No	Visible if P2 = 3 and P111 = Boiler
2	28	Master/slave control of two machines	Yes/No	No	
2	29	Total recovery	Yes/No	No	If P2 = 2
2	29.1	Frost protection during heat recovery	Yes/No	No	
<b>Breakdown</b>					
3	30	High pressure, HP 1 sensor	10 to 50 b (resolution: 0.1)	34 45 with R410A	
3	31	Low pressure, HP 1 sensor	-1 to 10 b (resolution: 0.1)	-0.5 0 with R410A	
3	32	High pressure, HP 2 sensor	10 to 50 b (resolution: 0.1)	34 45 with R410A	If P3 = 2
3	33	Low pressure, HP 2 sensor	-1 to 10 b (resolution: 0.1)	-0.5 0 with R410A	If P3 = 2

Access level	No.	Description	Setting	Default	Display conditions
<b>OPTION</b>					
<b>Breakdown (continued)</b>					
3	36	High pressure, LP 1 sensor	10 to 50 b (resolution: 0.1)	34 45 with R410A 17.3 b if P42 = VCM	
3	37	Low pressure, LP 1 sensor	-1 to 10 b (resolution: 0.1)	-0.5 0 with R410A	
3	38	High pressure, LP 2 sensor	10 to 50 b (resolution: 0.1)	34 45 with R410A 17.3 b if P42 = VCM	If P3 = 2
3	39	Low pressure, LP 2 sensor	-1 to 10 b (resolution: 0.1)	-0.5 0 with R410A	If P3 = 2
3	42	Electronic expansion valve	No/ALCO/VCM	No	
3	43	Superheat protection	Yes/No	No	
3	44	Minimum superheat	0 to 5 K (resolution: 0.1)	0.5 K	If P43 = Yes
3	45	Maximum overheating	10 to 20 K (resolution: 0.1)	15.0 K	If P43 = Yes
3	50	SCP (runtime + off)	3 to 10 min. (resolution: 1)	5	
3	51	Discharge temperature limit	60 to 145°C (resolution: 1)	145°C if Cop.** 135°C if Man.** 125°C if R410A and P7 = Cop**	
3	52	Water line frost protection limit	-25 to 6°C (resolution: 0.1)	2 if P1 = R22, 4 if P1 = 407C, R134a, R404 and 3 if R410A	P52 ≥ 2°C if P22 = Yes
3	53	Δ for refrigerant frost protection limit/P52	2 to 15 K (resolution: 0.1)	10 5 with R410A 7 if P7 = INVERTER	Refrigerant frost protection limit = P52-P53, if P08 ≠ SWEP DOUBLE
		Δ for the frost limit on LP saturation temperature			If P08 = SWEP DOUBLE
3	54	HP fault threshold	15 to 45 b (resolution: 0.1)	27.5 if P1 = R407C or R22 19 if P1 = R134a 24 if P1 = R404a 40.2 b if R410A	
3	55	LP fault threshold	0.1 to 5 b (resolution: 0.1)	If P2 = 3: 0.5 b If P2 ≠ 3: (1.5 b if P1 = R22, R407C, R404a) and (0.5 b if P1 = R134a) 2.5 b with R410A	
3	58	LP slope factor	0 to 5 b (resolution: 0.5)	1	If P2 = 1, 2 or 3
3	59	Water outlet temperature slope factor	0 to 1 (resolution: 0.1)	0 if P2 = 1 0.5 if P2 = 2 and 3	If P2 = 1, 2, 3
3	63	Minimum HP limit	5 to 25 b (resolution: 0.1)	13 if R22-R407C 8b with R134a 15 b with R404a 18 b with R410A	If P2 = water-to-water
3	64	Optimised frost protection	Yes - No	Yes	If P1 = R410A, P2 = 2 or 3
3	65	Delta T/Heat exchanger type	0 - 10	0	If P64 = Yes: confirm
3	66	Start-up time delay	0 to 300 seconds	120s	If P7 = INVERTER
3	67	Oil warming time delay	Yes/No	Yes	If P7 = INVERTER
2	99	Parameter locking	No - Yes	No	

\*\*Cop. = Copeland; Man. = Maneurop

Access level	No.	Description	Setting	Default	Display conditions
<b>Customer Configuration</b>					
2	100	Language	F - GB - D - SP - I	F	
2	101	Date	DAy/MONth/YEar		
2	102	Hour	HOUrs/Minutes		
1	103	Control type	Local - remote (BMS)	Local	
2	104	Leak detection	Yes - No	NO	
2	104.1	Leak detection time delay	0 to 5 min	1 min	If P104 = Yes
2	108	Pump 2 control	Depending on control mode Depending on On/Off if P2 = 1	Depending on On/Off	Visible if P2 = 1
2	109	Pump 2 'on' time delay	15 to 90 seconds (resolution: 5 seconds)	15	Visible if P2 = 1 and P108 = f (Control)
2	111	Configurable output	Max. power/Boiler/Cooling-heating / <b>Helping on all faults on air-to-water only</b>	P max	
2	112	Number of electric stages	1 to 4	2	Visible if P22 = Yes
2	113	Configurable input	Disabled/Load shedding/Override	Disabled	Visible if P22 = Yes
3	115	Exchanger frost detection enabled	Yes - No	Yes	Visible if P2 = 1, 2, 3
3	116	Drycooler link	Yes - No	No	
2	117	Power input limitation	No permanent – Yes by on/off input – Yes by bus	No	P 15.1 = Yes
2	118.1	Maximum power level	<b>15 to 400 kW</b>	<b>200</b>	P 15.1 = Yes and P117 ≠ No
<b>Setpoint Management</b>					
1	119	Operating mode	1 - Cooling 2 - Heating 3 - Cooling/heating via console 4 - Cooling/heating via on/off input 5 - Automatic cooling/heating based on outdoor temperature	Cooling	If P2 = 1 or 3 = All If P2 = 2 = Cooling only
1	120	Number of setpoints	1 - 2 via console - 2 via on/off input - 3 Setpoint managed by 4-20 mA signal	1	
1	121	Cooling setpoint 1	P52 + 1 K at 30°C (resolution: 0.1)	20	If P2 = 1, 2 or 3 P119 ≠ Heating
1	122	Cooling setpoint 2	P52 + 1 K at 30°C (resolution: 0.1)	15	If P120 = 2, P2 = 1, 2 or 3, P119 ≠ Heating
1	123	Heating setpoint 1	20 to 60°C (resolution: 0.1)	25	P119 ≠ Cooling
1	124	Heating setpoint 2	20 to 60°C (resolution: 0.1)	20	P119 ≠ Cooling, P120 = 2
1	125.1	Low setpoint (4-20 mA) during cooling:	P52 + 3 K at 30°C	P52 + 3	Displayed if P120 = 3 and in cooling mode
1	125.2	Low setpoint (4-20 mA) during heating:	10 to 60°C	20	Displayed if P120 = 3 and in heating mode
1	126.1	High setpoint (4-20 mA) in cooling mode:	P125.1 ± 5 K at 30°C with minimum value of P52 + 3	20	Displayed if P120 = 3 and in cooling mode
1	126.2	High setpoint (4-20 mA) in heating mode:	P125.2 ± 5 K at 60°C with minimum value of 10°C.	40	Displayed if P120 = 3 and in heating mode
1	127	Cooling setpoint adjustment = f (out. temp.)	No - Yes	Yes	If P2 = 1, 2 or 3 and P119 ≠ Heating
1	128	<b>Outdoor temperature</b> at start of drift	-20 to 55°C (resolution: 1)	25	If P127 = Yes
1	129	<b>Outdoor temperature</b> at end of drift	P128 + 5 K at 60°C (resolution: 1)	35	If P127 = Yes
1	130	Maximum setpoint at end of drift	P52 + 1 K at 30°C (resolution: 0.1)	10	If P127 = Yes
1	131	Heating setpoint adjustment = f (out. temp.)	No - Yes	Yes	If P2 = 1 or 3 and P119 ≠ Cooling
1	132	<b>Outdoor temperature</b> at start of drift	-20 to 55°C (resolution: 1)	16	If P131 = Yes
1	133	<b>Outdoor temperature</b> at end of drift	-25 to P132 - 5 K (resolution: 1)	-7	If P131 = Yes
1	134	Maximum setpoint at end of drift	Highest setpoint if P120 ≠ 1 or setpoint if P120 = 1 at 60°C (resolution: 0.1)	45	If P131 = Yes
1	135	Minimum boiler drift setpoint	30 to 55°C	50°C	If P111 = Boiler
1	136	Maximum air temperature in automatic heating mode	- 5 to 25°C (resolution 1)	16	If P119 = 5
1	137	Minimum air temperature in automatic cooling mode	P136 + 2 to 40°C (resolution: 1)	20	If P119 = 5



Access level	No.	Description	Setting	Default	Display conditions
<b>Control</b>					
2	141	Control mode	1- Return 3- Water supply 4- Supply with compensation	1	
2	142	Water loop winter protection	No - Yes	No	Visible if P2 = 1 and P141 = 1 and heating mode Visible if P2 = 1 and cooling mode Visible if P2 = 2 or 3
2	143	Stage differential	0.5 to 5 K (resolution: 0.5)	2 1.5	If P141 = 1, 2 if P7 = INVERTER
2	144	Interstage differential	0.5 to 5 K (resolution: 0.5)	1.5	
<b>Supply with compensation by return</b>					
2	145	P coefficient	0.3 to 2 (resolution: 0.1)	1	If P141 = 3, 4 and P7 ≠ INVERTER
2	146	I coefficient	0 to 1 (resolution: 0.1)	0	If P141 = 3, 4 and P7 ≠ INVERTER
2	147	D coefficient	0 to 1 (resolution: 0.1)	0	If P141 = 3, 4 and P7 ≠ INVERTER
2	148	T coefficient	10 to 240 seconds (resolution: 10)	60	If P141 = 3, 4 and P7 ≠ INVERTER
2	150	Compensation of coefficient	0.1 to 1 (resolution: 0.1)	0.5	If P141 = 4
2	151	Compensation of time	5 to P148-2 (resolution: 1)	10	If P141 = 4
<b>For storage control (Cristopia)</b>					
3	154	Storage	Yes/No	No	If P119 ≠ 2, P120 ≠ 1 and P120 ≠ 4
3	155	ΔT of control	0.5 to 10°C (resolution: 0.5)	5	If P154 = Yes
<b>Defrosting</b>					
3	157	Temperature at start of defrosting	-5 to 0°C (resolution: 0.5)	-2	If P2 = 3
3	158	Temperature at end of defrosting	10 to 30°C (resolution: 1)	15 if R407C otherwise 25	If P2 = 3
3	159	Frosting time calculation	Fixed time Optimised	Optimised	If P2 = 3
3	160	Fixed time	30-45-60	45	If P2 = 3
3	161	Coil frosting factor	0 to 2 (resolution: 0.01)	0.3	If P159 = Optimised
3	162	ΔT correction based on outdoor temperature	0 to 1 (resolution: 0.01)	0.2	If P159 = Optimised
3	163	CP off time delay for defrosting cycle	0 to 5 min.	60 s	P2 = 3 if P7 ≠ INVERTER
3	164	ΔP defrosting HP interlocking fan	1 to 20 b (resolution: 0.5)	2	If P2 = 3, (P HPR = P54 - P164)
3	165	DHP differential	1 to 5 b (resolution: 0.5)	2	If P2 = 3
3	166	Defrosting HP control coefficient	1 to 5 b (resolution: 1)	3	If P21 ≠ 1
<b>Charge limit</b>					
2	171	Maximum return temperature, stage 2	20 to 50°C (resolution: 1)	35	If P4 + P5 ≥ 2 and P119 ≠ Heating
<b>Fan management</b>					
2	180	Number of HP control stages per circuit	1 to 2 if P3 = 1 2 to 4 if P3 = 2 and P11 = intertwined 2 or 3 if P3 = 2 and P11 = split 3 if P3 = 2 and P11 = mixed	1 if P3 = 1 2 if P3 = 2 and P11 = intertwined 2 if P3 = 2 and P11 = split 3 if P3 = 2 and P11 = mixed	Visible if P2 = 2 or 3 + P10 = propeller
2	181	HP control setpoint	12 to 17 b (resolution: 0.5) if P1 = R407C or R22 14 to 20 b (resolution: 0.5) if P1 = R404a 7 to 13 b (resolution: 0.5) if P1 = R134a 19 to 27 b (resolution: 0.5) if P1 = R410A 13.4 to 27 b if P7 = INVERTER	12 14 7 19	Visible if P2 = 3 or P2 = 2 + P10 = propeller
2	182	Outdoor air temperature, forced HP	10 to 40 (resolution: 1)	25	Visible if P2 = 3 or 2 + P10 = propeller
2	183	Stage differential, HP control	2 to 8 b (resolution: 0.5)	4	Visible if P2 = 3 or 2 + P10 = propeller
2	184	Interstage differential, HP control	0.5 to 3 (resolution: 0.5) 2 to 4 (resolution: 0.5)	1 3	Visible if P2 = 3 or 2 + P10 = propeller If P180 = 1 (Low noise function)

Access level	No.	Description	Setting	Default	Display conditions
<b>High Pressure control</b>					
3	191	Low Noise operation	Yes - No	No	If P1 = R410A and P2 = 2, 3 or 4 and P180 = 1
2	192	Max. fan speed threshold	5 to 10 V	8.0 5.6 V if P7 = INVERTER	- If P7 ≠ Inverter and P10 = Pressure (P21 = 2 or 3, P180 = 1 and hidden) If P7 = Inverter and P21 = Yes
3	193	Shifting of HP setpoint during total recovery	5 to 14 (resolution: 0.5)	8 if P21 = 1 12 if P21 = 2 or 3	If P29 = Yes
3	195	ΔP for power reduction	0.1 to 1 b (resolution: 0.1)	0.3	If P4 = P5 ≠ 1
3	196	ΔP return to normal condensation control	0.1 to 2 b (resolution: 0.1)	1 1.5 with R410A	Visible if P2 = 3 or 2 + P10 = propeller
2	197	Value at 0 V	19 to 28 if P26 = 2WV 10 to 25°C if P26 = 3WV	19b 20°C	Visible if P2 = Water-to-Water and P3 = 1 Visible if P2 = Water-to-Water
2	198	Value at 10 V	28 to 39 if P26 = 2WV 25 at 40°C if P26 = 3WV	28b 30°C	Visible if P2 = Water-to-Water and P3 = 1 Visible if P2 = Water-to-Water
<b>Limits</b>					
3	220	Outdoor temperature, unit winter protection	2 to 10°C (resolution: 1)	2	If cooling and P142 = Yes If P2 = Air-to-water
3	222	Outdoor temperature differential, unit winter protection	1 to 10 K (resolution: 1)	2	If cooling and P142 = Yes If P2 = Air-to-water
3	225	Minimum outdoor air temperature in Heating mode	-25 to 5°C (resolution: 1)	-10 -20	If P119 ≠ cooling and P2 = 3 If P7 = INVERTER
3	225.1	Maximum outdoor air temperature in Cooling mode	35 to 50°C (resolution: 1)	DISABLED	
3	225.2	Maximum outdoor air temperature in Heating mode	-5 to +25°C (resolution: 1)	DISABLED	if P2 = water-to-water and reversible air-to-water when P119 ≠ 1
3	225.3	Minimum outdoor air temperature in Cooling mode	-20 to +25°C (resolution: 1)	DISABLED	if P2 = water-to-water and reversible air-to-water when P119 ≠ 2
3	226	Outdoor temperature Boiler operation authorisation	P225 at 25°C if P2 = 3 and P119 ≠ cooling -20 to 25°C if P2 = 1 and P119 ≠ cooling	5	(resolution: 1)
2	230	On authorisation, stage 1 circuit 1	No - Yes	Yes	
2	231	On authorisation, stage 2 circuit 1	No - Yes	Yes	If P4 = 2
2	232	On authorisation, stage 1 circuit 2	No - Yes	Yes	If P3 = 2
2	233	On authorisation, stage 2 circuit 2	No - Yes	Yes	If P5 = 2, P3 = 2
2	235	On authorisation, electric stage 1	No - Yes	Yes	If P22 = Yes
2	236	On authorisation, electric stage 2	No - Yes	Yes	If P22 = Yes
2	237	On authorisation, electric stage 3	No - Yes	Yes	If P22 = Yes
2	238	On authorisation, electric stage 4	No - Yes	Yes	If P22 = Yes and P112 = 4
<b>Read-only</b>					
1	250	LED test			
1	251	Control setpoint			If P141 ≠ 5 and ≠ 6
1	252	Outdoor air temperature			
1	255	Water inlet temperature, heat exchanger 1			
1	256	Water outlet temperature, heat exchanger 1			
1	257	Hot water inlet temp., condenser			If P2 = 1 and P141 = 1
1	258	Hot water outlet temp., condenser			If P2 = 1 and P141 = 3
1	259	Refrigerant temperature, circuit 1 coils A-B C-D			If P2 = 3 If P2 = 3 and P14 = 2 If P2 = 3 and P14 = 4
1	260	Refrigerant temperature, heat exchanger 1			If P2 = 1 or 2
1	261	Manifold water outlet temperature			If P6 = 2 - P2 = 1, 2 or 3
1	262	Water outlet temperature, heat exchanger 2			If P6 = 2
1	263	Refrigerant temperature, circuit 2 coils A-B C-D			If P2 = 3 and P3 = 2 If P2 = 3 and P3 = 2 and P14 = 2 If P2 = 3 and P3 = 2 and P14 = 4
1	264	Refrigerant temperature, heat exchanger 2			If P2 = 1 or 2 and if P6 = 2
1	265	Exchanger ambient temperature			If P2 = Air-to-water
1	266	Calculated frosting time, circuit 1			If P2 = 3,
1	267	Calculated frosting time, circuit 2			If P2 = 3 and P3 = 2

Access level	No.	Description	Setting	Default	Display conditions
<b>Read-only (continued)</b>					
1	268	Value of reference $\Delta T$ for defrosting of circuit 1			If P159 = Optimised
1	269	Value of reference $\Delta T$ for defrosting of circuit 2			If P159 = Optimised and P3 = 2
1	270	Controller action time delay			
1	271	DHP on differential			If P2 = 3
1	273.1	Supply voltage			If P15.1 = Yes
1	274.1	Machine current input			If P15.1 = Yes
1	275.1	Machine power input			If P15.1 = Yes
1	276.1	Electrical power consumed			If P15.1 = Yes
1	285	Runtime in heating mode			If P119 $\neq$ Cooling
1	286	Runtime in cooling mode			If P119 $\neq$ Heating
1	287	Pump 1 runtime (in hours)			
1	288	Pump 2 runtime (in hours)			If (P2 = 1) or P25 = 2
1	289	No. of times P99 set to "No"			
1	290	No. of water flow cut-offs in 1 hour			Visible if (cooling and P2 = 1) or if P2 = 3 or if P2 = 2 and P25 $\neq$ 2
1	291	Leak detected in circuit 1			Visible if P104 = Yes
1	291.1	Leak detected in circuit 2			Visible if P104 = Yes
<b>Circuit 1</b>					
1	300	Circuit 1 HP			
1	300.1	Circuit 1 HP control setpoint			If P3 = 1 or 2 and P11 = Intertwined
1	301	Circuit 1 condensation temperature	See appendix		
1	302.1	Discharge temperature 1			
1	302.2	Discharge temperature 2			If P4 = 2
1	303.1	Desuperheat on discharge 1	P302.1 - P301		
1	303.2	Desuperheat on discharge 2	P302.2 - P301		If P4 = 2
1	304	Circuit 1 LP			
1	305	Circuit 1 evaporation temperature	See appendix		
1	306	Circuit 1 suction temperature	$^{\circ}\text{C}$		
1	307	Circuit 1 superheat	$^{\circ}\text{C}$		
1	308	Number of HP1 cut-offs in 24 hours			
1	309	Number of LP1 cut-offs in 24 hours			
1	310	Number of starts, stage 1, circuit 1			
1	311	Runtime (in hours), stage 1, circuit 1			
1	312	SCP, stage 1, circuit 1			
1	313	Number of starts, stage 2, circuit 1			If P4 = 2
1	314	Runtime (in hours), stage 2, circuit 1			If P4 = 2
1	315	SCP, stage 2, circuit 1			If P4 = 2
1	322	No. of water line frost protection cut-offs, circuit 1			
1	323	No. of refrigerant line frost protection cut-offs, circuit 1			If P2 $\neq$ 3
1	324.1	No. of cut-offs caused by discharge temperature 1 in 24 hours			
1	324.2	No. of cut-offs caused by discharge temperature 2 in 24 hours			If P4 = 2
1	325	Opening of circuit 1 expansion valve	%		If P42 = VCM and P3 = 1
1	326	Circuit 1 liquid temperature	$^{\circ}\text{C}$		If P2 = 1 or 2 or (3 + cooling mode)
1	327	Circuit 1 subcooling	$^{\circ}\text{C}$		If P2 = 1 or 2 or (3 + cooling mode)
1	328	No. of cut-offs caused by C1 electronic expansion valve fault in 24 hours			If P42 = ALCO
<b>Circuit 2</b>					
1	330	Circuit 2 HP			If P3 = 2
1	330.1	Circuit 2 HP control setpoint			If P3 = 2 and P11 $\neq$ Intertwined
1	331	Circuit 2 condensation temperature	See appendix		If P3 = 2
1	332.1	Discharge temperature 3 Discharge temperature 2	$^{\circ}\text{C}$		If P3 = 2 and P4 = 2 If P3 = 2 and P4 = 1
1	332.2	Discharge temperature 4	$^{\circ}\text{C}$		If P3 = 2 and P5 = 2
1	333.1	Desuperheat on discharge 3 Desuperheat on discharge 2	P332.1 - P331		If P3 = 2 and P4 = 2 If P3 = 2 and P4 = 1

Access level	No.	Description	Setting	Default	Display conditions
<b>Circuit 2 (continued)</b>					
1	333.2	Desuperheat on discharge 4	P332.2 - P331		If P3 = 2 and P5 = 2
1	334	Circuit 2 LP			If P3 = 2
1	335	Circuit 2 evaporation temperature	See appendix		If P3 = 2
1	336	Circuit 2 suction temperature	°C		If P3 = 2
1	337	Circuit 2 superheat	°C		If P3 = 2
1	338	Number of HP2 cut-offs in 24 hours			If P3 = 2
1	339	Number of LP2 cut-offs in 24 hours			If P3 = 2
1	340	Number of starts, stage 1, circuit 2			If P3 = 2
1	341	Runtime (in hours). Stage 1, circuit 2			If P3 = 2
1	342	SCP, stage 1, circuit 2			If P3 = 2
1	343	Number of starts, stage 2, circuit 2			If P3 = 2, P5 = 2
1	344	Runtime (in hours). Stage 2, circuit 2			If P3 = 2, P5 = 2
1	345	SCP, stage 2, circuit 2			If P3 = 2, P5 = 2
1	352	No. of water line frost protection cut-offs, circuit 2			If P3 = 2 and P2 ≠ 4, 5
1	353	No. of refrigerant line frost protection cut-offs, circuit 2			
1	354.1	No. of cut-offs caused by discharge temperature 2 in 24 hours No. of cut-offs caused by discharge temperature 3 in 24 hours			If P3 = 2 and P4 = 1 If P3 = 2 and P4 = 2
1	354.2	No. of cut-offs caused by discharge T° 4 in 24 hours			If P3 = 2 and P5 = 2
1	355	Opening of circuit 2 expansion valve	%		P42 = VCM and P3 = 2
1	356	Circuit 2 liquid temperature	°C		If [P2 = 1 or 2 or (3 + cooling mode)] and P3 = 2
1	357	Circuit 2 subcooling	°C		If [P2 = 1 or 2 or (3 + cooling mode)] and P3 = 2
1	358	No. of cut-offs caused by C1 electronic expansion valve fault in 24 hours			If P42 = ALCO
<b>INPUTS</b>					
1	400	Automatic machine operation control	Open/Closed		
1	402	Setpoint 1/Setpoint 2 selection	Open/Closed		If P120 = 2 via On/Off control
1	403	Water flow check	Open/Closed		
1	404	Fan fault check	Open/Closed		If P2 ≠ 1 or 5
1	405	Cooling/Heating input check	Open/Closed		If P119 = Cooling/Heating via On/Off control
1	406	Phase controller	Open/Closed		
1	407	Recovery operating mode selection	Open/Closed		If P29 = Yes
1	408	Check of fault input for auxiliary electric heater 1	Open/Closed		If P22 = Yes
1	409	Check of fault input for auxiliary electric heater 2	Open/Closed		If P22 = Yes
1	410	Check of configurable auxiliary electric heater input	Open/Closed		If P22 = Yes
1	414	Check of override/load shedding input 1	Open/Closed		
1	415	Check of override/load shedding input 2	Open/Closed		If P4 = 2
1	416	Check of override/load shedding input 3	Open/Closed		If P3 = 2
1	417	Check of override/load shedding input 4	Open/Closed		If P5 = 2
1	418	Check of manual HP1 pressure switch input	Open/Closed		
1	419	Check of stage 1, circuit 1 fault input	Open/Closed		
1	420	Check of stage 2, circuit 1 fault input	Open/Closed		If P4 = 2
1	422	Check of manual HP2 pressure switch input	Open/Closed		If P3 = 2
1	423	Check of stage 1, circuit 2 fault input	Open/Closed		If P3 = 2
1	424	Check of stage 2, circuit 2 fault input	Open/Closed		If P5 = 2
1	425	Check of fault input for circuit 1 electronic expansion valve	Open/Closed		If P42 = ALCO
1	426	Check of fault input for circuit 2 electronic expansion valve	Open/Closed		If P42 = ALCO
<b>OUTPUTS</b>					
1	430	Pump 1 control state	On/Off		
1	431	Pump 2 control state	On/Off		If (P2 = 1) or P25 = 2
1	432	State of circuit 1 Y/C control output	On/Off		If P2 = 3
1	433	State of circuit 2 Y/C control output	On/Off		If P2 = 3 and P3 = 2
1	435	State of heat trace cable control output	On/Off		If P2 ≠ 1 (water-to-water)
1	436	State of heater control output	On/Off		If P2 ≠ 1 (water-to-water)

Access level	No.	Description	Setting	Default	Display conditions
<b>OUTPUTS (continued)</b>					
1	437	State of recovery heat trace cable control output	On/Off		If P2 ≠ 1 (water-to-water) and P29.1 = Yes
1	438	State of maximum power output	On/Off		If P111 = Max. power
1	439	State of boiler output	On/Off		If P111 = Boiler
1	440	State of cooling/heating output	On/Off		If P111 = Cooling/Heating
1	441	State of HP control output, stage 1, circuit 1	On/Off if P21 = without High Temperature mode/Low Noise mode/Off if P191 = acoustic		If P21 = without, P2 = 2, 3
1	442	State of HP control output, stage 2, circuit 1	On/Off		If P180 = 2 and P3 = 1, P2 = 2, 3
1	443	State of HP control output, stage 1, circuit 2	On/Off		If P180 = 1 and P3 = 2, P2 = 2, 3
1	444	State of HP control output, stage 2, circuit 2	On/Off		If P180 = 2 and P3 = 2, P2 = 2, 3
1	445	State of HP control output, stage 3, circuit 1 or State of HP control output, common stage 1	On/Off		If P180 = 3 and P3 = 2, P11 = split, P2 = 2, 3 or If P180 = 3 and P3 = 2, P11 = mixed
1	446	State of HP control output, stage 3, circuit 2 or State of HP control output, common stage 3	On/Off		If P180 = 3 and P3 = 2, P11 = split, P2 = 2, 3 or If P180 = 3 and P3 = 2, P11 = mixed
1	447	Driving voltage, stage 1, HP control	0-10 V		If P21 = 2 or 3 and P11 = Intertwined
1	448	Driving voltage, stage 1, circuit 1, HP control	0-10 V		If P21 = 2 or 3 and P11 = split or mixed
1	449	Driving voltage, stage 1, circuit 2, HP control	0-10 V		If P21 = 2 or 3 and P11 = split or mixed
1	450	Driving voltage, common stage 1, HP control	0-10 V		If P21 = 2 or 3 and P11 = Mixed
1	451	State of circuit 1 balance valve output	On/Off		If P12 = Yes
1	452	State of circuit 2 balance valve output	On/Off		If P12 = Yes
1	530	State of electric stage 1	On/Off		If P22 = Yes
1	531	State of electric stage 2	On/Off		If P22 = Yes
1	532	State of electric stage 3	On/Off		If P22 = Yes
1	533	State of electric stage 4	On/Off		If P22 = Yes and P112 = 4
1	535	Air blade percentage information	0-100 %		If P20 = Yes and P10 = Centrifugal
1	555	CPU version number			
1	556	Console version number	*		
1	557	Version number of circuit 2 board			If P3 = 2
1	558	Version number of changeover board			If P2 = reversible air-to-water
1	559	Version number of auxiliary heater board			If P22 = Yes
1	560	Version number of circuit 1 expansion valve	XX.YY VCM XX.YY		If P42 = VCM and P3 = 1
1	561	Version number of circuit 2 expansion valve	XX.YY VCM XX.YY		If P42 = VCM and P3 = 2
1	570	"SO" order number"			To be entered via a PC
1	571	MO number			To be entered via a PC
1	572	Machine identification name			To be entered via a PC
1	573	Machine identification number			To be entered via a PC
<b>ELECTRONIC EXPANSION VALVE</b>					
<b>Circuit 1</b>					
3	601	Circuit 1 valve type	EX4 - EX5 - EX6 - EX7 - EX8	EX4	If P42 = VCM and P3 = 2
3	602	Circuit 1 superheat setpoint	0.5 to 30°C	6	If P42 = VCM and P3 = 1
3	603	Circuit 1 MOP point	Yes - No	No	If P42 = VCM and P3 = 1
3	604	Circuit 1 MOP value	+ 5 to 25°C	15	If P42 = VCM, P603 = Yes and P3 = 1
3	605	Opening of C1 valve when air conditioning started	10 to 100 %	50	If P42 = VCM and P3 = 1
3	606	Opening of C1 valve when heat pump started	10 to 100 %	20	If P42 = VCM and P3 = 1 and P2 = reversible air-to-water
3	607	Opening time at start-up, C1	1 to 60 seconds	5	If P42 = VCM and P3 = 1
3	608	Circuit 1 slow mode	Yes/No	No	If P42 = VCM and P3 = 1
<b>Circuit 2</b>					
3	611	Circuit 2 valve type	EX4 - EX5 - EX6 - EX7 - EX8	EX4	If P42 = VCM and P3 = 2
3	612	Circuit 2 superheat setpoint	0.5 to 30°C	6	If P42 = VCM and P3 = 2
3	613	Circuit 2 MOP point	Yes - No	No	If P42 = VCM and P3 = 2
3	614	Circuit 2 MOP value	+ 5 to 25°C	15	If P42 = VCM and P609 = Yes and P3 = 2
3	615	Opening of C2 valve when air conditioning started	10 to 100 %	50	If P42 = VCM and P3 = 2

Access level	No.	Description	Setting	Default	Display conditions
<b>Circuit 2 (continued)</b>					
3	616	Opening of C2 valve when heat pump started	10 to 100 %	20	If P42 = VCM and P3 = 2 and P2 = reversible air-to-water
3	617	Opening time at start-up, C2	1 to 60 seconds	5	If P42 = VCM and P3 = 2
3	618	Circuit 2 slow mode			If P42 = VCM and P3 = 2
<b>COMMUNICATION</b>					
1	700	Communication protocol	BUS MODE	BUS MODE	
1	701	Transmission speed	Adjustable: 4800, 9600 baud or 9600 jbus	9600 baud	
1	702	Parity	Without, even or odd	Without	
1	703	Number of stop bits	1 or 2	1	
1	704	Swapped real number format	Yes or No	Yes	
1	705	Bus number	0 to 255	1	
<b>MASTER/SLAVE (2 MACHINES) If P28 = Yes</b>					
2	800	Master machine on loop	Yes/No	No	If P28 = Yes
2	801	Backup machine	Yes/No	No	If P28 = Yes
2	802	Switch backup machine	Yes/No	No	If P28 = Yes
2	803	Name of backup machine	Master/Slave	Slave	If P28 = Yes
2	804	Loop control type	CASCADE or PARALLEL or PROGRESSIVE	CASCADE	If P28 = Yes
2	805	Machine differential	0.5 to 5°C	1.5	If P28 = Yes
2	806	Differential between machines	1 to 10°C	4.0	If P28 = Yes
2	807	Maximum differential, additional machine	1 to 10°C	0.0	if P801 = Yes
2	808	Time delay between machines	0 to 60 min.	1	If P28 = Yes
2	809	Machine 1 'on' authorisation	Yes/No	Yes	If P28 = Yes
2	810	Machine 2 'on' authorisation	Yes/No	Yes	If P28 = Yes
2	811	Pump turned off by control	No Yes, except for one Yes, machine off	No	
<b>MAINTENANCE</b>					
2	900	F gas tightness check reminder	No -03-06-12 months	No	
2	901	F gas check reset			If P900 ≠ No
2	910	Maintenance check reminder	No -in hours-in months	No	
2	911	Maintenance check frequency	1 to 9999 hrs 1 to 99 months	2000 hrs 12 months	If P910 is in hours If P910 is in months
2	912	Maintenance check reset			

## 7 MANAGEMENT OF THE DRYCOOLER CONTROLLER PARAMETERS

Setting parameter P116 (Drycooler link) to "Yes" provides access to all Drycooler controller parameters in read/write mode only if a bus connection has been created between the two items of equipment

1 3 -            D R Y C O O L E R

- Menu 13 allows all information about the Drycooler controller to be displayed on the heat pump or chiller console without having **the** console mounted on the Drycooler.
- The Drycool controller parameters are preceded by the letter A to differentiate them from those of the heat pump or chiller controller.
- If a Drycooler equipped with its console is connected to a chiller or a heat pump and P116 is set to 'Yes', neither console has priority over the other.
- If menu 13 remains open for 1 hour and no buttons are pressed during this time, the screen switches to the controller menu for the chiller or heat pump.
- Parameter A99 (lock parameters) cannot be set to 'No' via the chiller or heat pump console.
- Parameter A116 (CW unit link) is not accessible via the chiller or heat pump console because setting A116 to 'No' will delete the link with the Drycooler console.
- Parameter A250 is not accessible because the LED test on the chiller or heat pump console is performed via parameter P250 on the controller of said console.
- The forced fan operation function on the console is not accessible via the chiller or heat pump console.

## 8 CONTENTS OF THE MENU

The ° symbol stands for °C in the electronic programming system.

Analogue values are displayed with one decimal place. The hundreds digit may be replaced by a negative sign when appropriate.

A selection symbol flashes at the left of the display.

Holding down the + or - buttons will cause increasingly faster scrolling (and change the units) in the list of parameters or when modifying parameter values.

### 8.1 MAIN menu

Scrolling through menus occurs line by line.

The + button is used to increment values and the - button is used to decrement values.

The first square at the top left flashes.

```

1 - S E T P O I N T S
2 - S T A T U S   O F   M A C H I N E S

3 - M E A S U R E D   V A L U E S
4 - M A C H I N E . P A R A M E T E R S

5 - A D J U S T M E N T . P A R A M E T E R S
6 - R E A D I N G . P A R A M E T E R S

7 - F A U L T   M E M O R Y
8 - T E S T   M O D E

9 - P R O G R A M M I N G
1 0 - E L E C T R O   E X P A N S I O N   V A L

1 1 -   C O M M U N I C A T I O N
1 2 -   M A S T E R / S L A V E

1 3 -   D R Y C O O L E R
1 4 -   A C C E S S   L E V E L   S E L E C T .
    
```

### 8.2 SETPOINTS menu

This menu gives quick access to settings for the control setpoints depending on the control mode and the selected operating mode.

P x x x	S T P	1	C O O L I N G	- x x . x °	} If P119 ≠ heating
P x x x	S T P	2	C O O L I N G	- x x . x °	
P x x x :	S T P	1	H E A T I N G	- x x . x °	} If P120 = 2 and if P119 ≠ heating
P x x x :	S T P	2	H E A T I N G	- x x . x °	
P x x x :	S T P	1	H E A T I N G	- x x . x °	} If P119 ≠ cooling
P x x x :	S T P	2	H E A T I N G	- x x . x °	
P x x x :	S T P	2	H E A T I N G	- x x . x °	} If P120 = 2 and P119 ≠ cooling
P x x x :	S T P	1	H E A T I N G	- x x . x °	

To move from parameter to parameter, press the + or - buttons. The letter **P** flashes when a parameter is selected.

To change the value of a selected parameter, press **OK**. The value can be changed when the cursor flashes at the bottom right. Use the +

button to raise the value, and the - button to lower it. When finished, press **OK** to confirm or **ESC** to cancel the changes.

When returning to menu 1 the last parameter consulted is displayed.

### 8.3 MACHINE STATUS menu

To enter the MACHINE STATUS menu, use the + or - buttons to position the cursor on 2 then press **OK**.

**8.3.1 Main table**

This screen reappears automatically after one hour if

No general faults occur, no controls are activated (via the console, modem, etc.), no general faults are reported and no automatic controls are closed:

DD / MM / YY	hh / mm
RETURN TEMP . : - xx . x °	
SET POINT : - xx . x °	↓
⊖ 1 OFF ⊖ 2 ON ⊖ 3 SCP ⊖ 4 SCP	

The ↓arrow appears if there is another message.

- If a general fault occurs on the main machine, the messages are displayed on lines 2 and 3 in the following order of importance:

MACHINE OFF
WATER FLOW FAULT

WATER FLOW FAULT
X CUT (S) IN 1H

MACHINE OFF
OUT TEMP . TOO LOW

MACHINE OFF
OUT TEMP . TOO HIGH

MACHINE OFF
PHASE CTRL LR FAULT

COMPRESSOR
DRIVER FAULT

{ If P7 = INVERTER

OUT . TEMP . SENSOR FAULT
J 7 / 1 - 2

{ If machine off

CONDENSER INLET
SENSOR FAULT J 7 / 5 - 6

CONDENSER OUTLET
SENSOR FAULT J 7 / 5 - 6

MANIF . WATER OUTLET
SENSOR FAULT ADD 2 J 4 / 2 - 3

{ If machine off

EXCH . 1 WATER OUTLET
SENSOR FAULT J 7 / 2 - 3

MACHINE OFF
OPERATING MODE CHANGE

If an automatic operation control is activated → the On/Off LED flashes:

MAINTAIN WATER LOOP
TEMPERATURE AT 30 °

WATER CIRCULATION
PUMP FORCED ON

UNIT STOP BY
REMOTE CONTACT

MACHINE OFF
ON / OFF



### 8.3.2 MACHINE STATUS table

This table appears only if any of the following messages must be displayed using the ↑ and ↓ buttons. The messages are displayed in the following order of priority:

M A C H I N E   S T A T U S F A N   F A U L T
P U M P   1   O N x x s
P U M P   2   O N x x s
W A T E R   R E T U R N   T .   L I M I T P O W E R   R E D U C .
E X C H A N G E R   A M B .   T E M P . D U R I N G   F R O S T   P R O T E C .
N O .   O F   S T A G E S   T O   B E S H U T   O F F :                    X
U N I T   D I S C H . T .   L I M I T O P T I M I S E D   O P E R A T I O N
E L E C   A U X   C T R L O U T   T E M P .   T O O   L O W
W A T E R   T E M P .   R I S I N G F O R   D E F R O S T I N G
O U T .   T E M P .   S E N S O R   F A U L T J 7 / 1 - 2
M A N I F . W A T E R   O U T L E T S E N S O R   F A U L T   A D D 2   J 4 / 2 - 3
E X C H A N G E R   A M B I E N T   T E M P . S E N S O R   F A U L T   J 7 / 5 - 6
H P   P R E S S U R E   C O N T R O L S T A G E   1   O N L Y
S E L F - R E G U L A T I N G C O N T R O L   M O D E

### 8.3.3 Table of “MACHINE STATUS circuit x fault” messages:

This table appears only if any of the following messages must be displayed using the ↑ and ↓ buttons. The messages are displayed in the following order of priority:

C I R C U I T   2   O F F L I N K   F A U L T
M O T O R   F A U L T S T A G E   x   C I R C U I T   x
C I R C U I T   B R E A K   x W A T E R   F R O S T   F A U L T
C I R C   X   H 2 O   F R O S T   F A U L T X   C U T ( S )   I N   2 4 H

C I R C U I T B R E A K x R E F R I G . F R O S T F A U L T	
C I R C X R E F F R O S T F A U L T X C U T ( S ) I N 2 4 H	
C I R C U I T B R E A K x H P F A U L T	
H P F A U L T C I R C x x x m n X C U T ( S ) I N 2 4 H	
C I R C U I T B R E A K x M A N U A L H P F A U L T	
C I R C U I T B R E A K x L P F A U L T	
C I R C U I T x L P F A U L T X C U T ( S ) I N 2 4 H	
S T A G E x O F F D I S C H A R G E F A U L T	
C I R C U I T B R E A K x D E F R O S T I N G I M P O S S I B L E	
D . T E M P F A U L T x x x m n X C U T ( S ) I N 2 4 H	
C I R C U I T X O F F E X P . V A L V E F A U L T	{ If P42 ≠ NO
F A U L T O N E X V X X C U T S I N 2 4 H	{ If P42 ≠ NO
B O A R D L I N K F A U L T C I R C U I T X E X V	{ If P42 = VCM
M O T O R F A U L T C I R C U I T X E X V	{ If P42 = VCM
C I R C U I T X O F F M I N . S U P E R H E A T F A U L T	
C I R C U I T X O F F M A X . S U P E R H E A T F A U L T	
M I N S U P E R H E A T F A U L T C X X C U T ( S ) I N 1 H	
M A X S U P E R H E A T F A U L T C X X C U T ( S ) I N 1 H	
E X C H . 1 W A T E R I N L E T S E N S O R F A U L T J 7 / 2 - 3	
E X C H . x W A T E R O U T L E T S E N S O R F A U L T J X / X - X	

S U C T I O N   T E M P .   S E N S O R F A U L T   C I R C . x   J x / x x - x x
E X C H . x   R E F R .   F R O S T P R O T .   S E N S .   F A U L T   J x / x - x
C O I L   x   C I R C U I T   x S E N S O R   F A U L T   J x / x - x
D . T E M P .   S E N S O R   X   F A U L T J x / x - x
L I Q U I D   T E M P .   S E N S O R F A U L T   C I R C   . x   J x / x x - x x
x P   x   S E N S O R   F A U L T I N L E T   J x / x x - x x
S T A G E   C I R C U I T x   A T M I N .   S T O P   x x m n x x s
S H O R T - C Y C L E   P R O T E C T I O N S T A G E x   C I R x   x x m n x x s
S T A G E   x   C I R C U I T   x F O R C E D   O F F
S T A G E   x   C I R C U I T   x T U R N I N G   O F F

Informational messages:

C X   R E F R I G   F R O S T   L I M . P O W E R   R E D U C .
C I R C . x   W A T E R   F R O S T   L I M . P O W E R   R E D U C .
C I R C U I T   x   H P   L I M I T P W R   R E D U C T I O N   x x m n
C I R C . X   D . T E M P   L I M I T R E D U C T I O N   x x m n
C I R C . x   M I N .   H P   L I M . P O W E R   R E D U C .
H P   P R E S S U R E   C O N T R O L S T A G E   1   O N L Y
C I R C U I T   X B E I N G   D E F R O S T E D

8.3.4 Electric stages table:

E L E C .   S T A G E S   S H U T   O F F B Y   L O A D   S H E D D I N G   I N P U T
E L E C .   S T A G E S   O V E R R I D D E N B Y   O V E R R I D E   I N P U T
E L E C T R I C   S T A G E   F O R C E D O F F   x

### 8.4 Measured values menu

To access the MEASURED VALUES menu, use the + or - buttons to position the cursor on 3, then press **OK** (the list of submenus can then be accessed).  
Position the cursor on **CIRCUIT 1** or **CIRCUIT 2** then press **OK**.  
The values for the circuit selected appear.

Use the + and - buttons to scroll through the tables at a rate of three rows at a time.  
Arrows in the reading can be ignored. The square at the bottom right flashes for the reading.  
Press the **ESC** button to return to the main menu.

Example:

Visible if P3 = 2	C I R C U I T 1	↑
	C I R C U I T 2	↓

For circuit 1:

Visible if P141 = 3	C L G R E T U R N C T R L	↑	Visible if P3 = 2 and if P141 ≠ 3
	C T R L S T P : - x x . x °	↓	
	W A T E R I N L E T : - x x . x °	↓	
Visible if P3 = 2	W A T E R o r M A N O U T L E T : x x . x °	↓	Visible if P3 = 2 and if P141 ≠ 3
	H P 1 : x x x . x b C O N T : + x x . x °	↑	
	B P 1 : x x x . x b E V A T : + x x . x °	↓	
Visible if water-to-water and operating mode ≠ heating	S U C T I O N T . x : + x x . x °	↓	Visible if P2 = 1 or 2, or 3 + cooling mode
	O V E R H E A T 1 : x x . x °	↑	
	D I S . T 1 : x x x ° D I S . T 2 : x x x °	↓	
Visible if P3 = 2	O U T D O O R T . : - x x . x °	↓	Visible if P3 = 2 and if P141 ≠ 3
	W A T E R O U T L E T 1 : - x x . x °	↑	
	W A T E R O U T L E T 2 : - x x . x °	↓	
Visible if P3 = 2	M A N . W A T E R O U T : - x x . x °	↓	Visible if P3 = 2 and if P141 ≠ 3
	R E F R I G . T . 1 + x x . x °	↑	
	L I Q U I D T E M P . 1 + x x . x °	↑	
Visible if water-to-water and operating mode ≠ heating	H O T W A T E R T . - x x . x	↓	Visible if P2 = 1 or 2, or 3 + cooling mode

For circuit 2:

The menu for circuit 2 is the same as for circuit 1, but with the digit 1 replaced by the digit 2. Thus, discharge temperature **REF 1** becomes **REF 2** (or **3** depending on the number of compressors per circuit) and **REF 2** becomes **discharge 4**

Message on first row:

H O T S U P P L Y C T R L	↑
H O T R E T U R N C T R L	↓
C L G R E T U R N C T R L	↑
S T O R A G E C T R L	↓
C O M P E N S A T I O N C T R L	↑

### 8.5 MACHINE PARAMETERS menu

To access the MACHINE PARAMETERS menu, use the + or - buttons to position the cursor on 4 then press **OK**.  
The display shows the list of configuration parameters.  
Use the + and - buttons to scroll through the tables at a rate of two rows at a time. To modify a parameter the configuration must be unlocked (via parameter P99). This turns off the machine.

•To change a value:

Press **OK** to enter the parameter. Use the + or - buttons to increment or decrement the value of the parameter then press **OK** to confirm the changes. Press **OK** to save the change or **ESC** to cancel. When a parameter value is being changed, the square at

the bottom right should flash.  
In the case of parameters, the letter **P** flashes.  
The text in messages scrolls in a loop.  
Numerical values (with adjustment ranges), however, do not scroll in a loop.

If a parameter is locked (P99 = yes), the  symbol is displayed at the top left.

To return to the main menu, press the **ESC** button repeatedly.

4 - M A C H I N E . P A R A M E T E R
---------------------------------------

If the user tries to access a locked parameter, the following message appears for 2 seconds before the parameter is redisplayed:

P A R A M E T E R L O C K E D
M O D I F I C A T I O N . I M P O S S I B L E

Once the user sets the "locking" parameter to "NO", the text is marked Pxx and the button symbol disappears. The following parameters can then be accessed:

Refrigerant type:

<b>P 0 1</b>	R E F R I G E R A N T :	R 4 0 7 c
<b>P 0 1</b>	R E F R I G E R A N T :	R 1 3 4 a
<b>P 0 1</b>	R E F R I G E R A N T :	R 4 1 0 a
<b>P 0 1</b>	R E F R I G E R A N T :	R 2 2

Unit type:

<b>P 0 2</b>	U N I T :	W A T E R - T O - W A T E R
<b>P 0 2</b>	U N I T :	A I R - T O - W A T E R
<b>P 0 2</b>	U N I T :	R E V E R S I B L E A I R - T O - W A T E R

Number of circuits:

<b>P 0 3</b>	N U M B E R O F C I R C U I T S	1
<b>P 0 3</b>	N U M B E R O F C I R C U I T S	2

Number of stages per circuit:

<b>P x x</b>	N O . O F S T A G E S O N	C I R C U I T x	1
<b>P x x</b>	N O . O F S T A G E S O N	C I R C U I T x	2

Number of evaporators:

<b>P 0 6</b>	N O . O F E V A P O R A T O R S	1
<b>P 0 6</b>	N O . O F E V A P O R A T O R S	2

Compressor suppliers:

<b>P 0 7</b>	C O M P R E S S O R	M A N E U R O P
<b>P 0 7</b>	C O M P R E S S O R	C O P E L A N D
<b>P 0 7</b>	C O M P R E S S O R	I N V E R T E R

Heat exchanger suppliers:

P 0 8	E X C H A N G E R	E X L
P 0 8	E X C H A N G E R	S W E P
P 0 8	E X C H A N G E R	S W E P D O U B L E
P 0 8	E X C H A N G E R	A L F A L A V A L

Fan type:

P 1 0	F A N T Y P E	P R O P E L L E R
P 1 0	F A N T Y P E	C E N T R I F U G A L
P 1 0	F A N T Y P E	P R E S S U R E

Coil type:

P 1 1	C O I L T Y P E	I N T E R T W I N E D
P 1 1	C O I L T Y P E	S P L I T
P 1 1	C O I L T Y P E	M I X E D

Presence of balance solenoid valve:

P 1 2	B A L A N C E	S V	Y E S
P 1 2	B A L A N C E	S V	N O

Tandem type:

P 1 3	B A L A N C E D T A N D E M	C O M P R E S S O R	Y E S
P 1 3	B A L A N C E D T A N D E M	C O M P R E S S O R	N O

Number of coil sensors per circuit:

P 1 4	N U M B E R O F C O I L S E N S O R	P E R C I R C U I T	1
P 1 4	N U M B E R O F C O I L S E N S O R	P E R C I R C U I T	2
P 1 4	N U M B E R O F C O I L S E N S O R	P E R C I R C U I T	4

All-season operation:

P 2 0	A L L - S E A S O N	O P E R A T I O N	N O
-------	---------------------	-------------------	-----

<b>P 2 0</b> A L L - S E A S O N O P E R A T I O N	Y E S
---	-------

Variable speed control board:

<b>P 2 1</b> V A R I A B L E S P E E D W I T H O U T
<b>P 2 1</b> V A R I A B L E S P E E D A C O U S T I C O P T I M I S A T I O N
<b>P 2 1</b> V A R I A B L E S P E E D E N E R G Y O P T I M I S A T I O N

Electric auxiliary heater board:

<b>P 2 2</b> E L E C T R I C A U X I L I A R Y H E A T E R S	N O
<b>P 2 2</b> E L E C T R I C A U X I L I A R Y H E A T E R S	Y E S

Number of pumps:

<b>P 2 5</b> N U M B E R O F P U M P S S U P P L I E D	0
<b>P 2 5</b> N U M B E R O F P U M P S S U P P L I E D	1
<b>P 2 5</b> N U M B E R O F P U M P S S U P P L I E D	2

0-10 V configurable output:

<b>P 2 6</b> 0 - 1 0 V P R O G R A M M A B L E O U T P U T	2 - W A Y V A L V E
<b>P 2 6</b> 0 - 1 0 V P R O G R A M M A B L E O U T P U T	3 - W A Y V A L V E

Pump controlled by operation of boiler:

<b>P 2 7</b> P U M P C O N T R O L L E D B Y B O I L E R	N O
<b>P 2 7</b> P U M P C O N T R O L L E D B Y B O I L E R	Y E S

Master/slave control of two machines:

<b>P 2 8</b> M A S T E R S L A V E 2 M A C H I N E S	N O
<b>P 2 8</b> M A S T E R S L A V E 2 M A C H I N E S	Y E S

Total recovery:

<b>P 2 9</b> T O T A L R E C O V E R Y	N O
<b>P 2 9</b> T O T A L R E C O V E R Y	Y E S

Frost protection for recovery option:

<b>P 2 9 . 1</b>	H E A T R E C O V . E X C H .	
	F R O S T P R O T E C T I O N	N O
<b>P 2 9 . 1</b>	H E A T R E C O V . E X C H .	
	F R O S T P R O T E C T I O N	Y E S

HP1/HP2 sensor high pressure:

Same with LP (Low Pressure) }	<b>P x x</b>	H P x S E N S O R	
		H I G H V A L U E	x x . x b

Same with LP (Low Pressure) HP1/HP2 sensor low pressure:

Same with LP (Low Pressure) }	<b>P x x</b>	H P x S E N S O R	
		L O W V A L U E	x x . x b

Compressor short-cycle protection:

<b>P 5 0</b>	C O M P R E S S O R S H O R T	
	C Y C L E P R O T E C T I O N	x x m n

Discharge temperature limit:

<b>P 5 1</b>	D I S C H A R G E T E M P .	
	L I M I T	x x x °

Water line frost protection limit:

<b>P 5 2</b>	H 2 O F R O S T P R O T .	
	L I M I T	- x x . x °

Refrigerant frost protection differential

Gives the freon frost limit = water frost limit – this differential

If P08≠SWEp double:

<b>P 5 3</b>	R E F R I G E R A N T F R O S T	
	P R O T . D I F F .	x x K

<b>P 5 3</b>	L P S A T . T E M P . F R O S T	
	P R O T . D I F F .	x x K

HP fault threshold:

<b>P 5 4</b>	H P F A U L T T H R E S H O L D	
		x x . x b

LP fault threshold:

<b>P 5 5</b>	L P F A U L T T H R E S H O L D	
		x x . x b

LP slope factor:

<b>P 5 8</b>	L P S L O P E	
	F A C T O R	x . x

Water outlet T slope factor:

<b>P 5 9</b>	W A T E R O U T L E T	
	T . S L O P E F A C T O R	x . x

LP fault threshold:

<b>P 6 3</b>	M I N . H P T H R E S H O L D	
		x x x . x b

Parameter locking:

<b>P 9 9</b>	L O C K	
		N O
<b>P 9 9</b>	L O C K	
		Y E S



**8.6 ADJUSTMENT PARAMETERS** menu

To access the ADJUSTMENT PARAMETERS menu, use the + or – buttons to position the cursor on 5 then press **OK**. The display shows the list of control parameters.

Example:

```
P x x S T A G E
D I F F E R E N T I A L           x x . x K
```

Pressing on the + and – buttons scrolls through the parameters two lines at a time.

**•To change a value:**

Press **OK** to enter the parameter. Use the + or – buttons to increment or decrement the value of the parameter then press **OK** to confirm the changes or **ESC** to cancel.

To return to the main menu, press the **ESC** button repeatedly.

```
5 - A D J U S T M E N T . P A R A M E T E R S
```

Language:

```
P 1 0 0 L A N G U A G E           F R A N C A I S
P 1 0 0 L A N G U A G E           E N G L I S H
P 1 0 0 L A N G U A G E           D E U T S C H
P 1 0 0 L A N G U A G E           E S P A Ñ O L
P 1 0 0 L A N G U A G E           N E D E R L A N D S
P 1 0 0 L A N G U A G E           I T A L I A N O
P 1 0 0 L A N G U A G E           P Y C C K
```

Control type:

```
P 1 0 3 C O N T R O L   T Y P E           L O C A L
P 1 0 3 C O N T R O L   T Y P E
R E M O T E   ( B M S ,   e t c . )
```

Pump 2 control:

Based either on the control or on the On/Off status of the unit }

```
P 1 0 8 P U M P   2   C O N T R O L
F U N C T I O N ( C T R L )
P 1 0 8 P U M P   2   C O N T R O L
F U N C T I O N ( O N / O F F )
```

Pump 2 'on' time delay:

```
P 1 0 9 P U M P   2   O N
T I M E   D E L A Y   x x S
```

Configurable output:

```
P 1 1 1 P R O G R A M M A B L E   O N / O F F
O U T P U T   M A X .   P O W E R
```

```

P 1 1 1   P R O G R A M M A B L E   O N / O F F
O U T P U T                               B O I L E R

P 1 1 1   P R O G R A M M A B L E   O N / O F F
O U T P U T   C O O L I N G / H E A T I N G

```

Number of electric stages:

```

P 1 1 2   N O .   O F   E L E C T R I C
S T A G E S                               0

```

Configurable input:

```

P 1 1 3   P R O G R A M M A B L E   I N P U T
A U X .   H E A T E R   D I S A B L E D

P 1 1 3   P R O G R A M M A B L E   I N P U T
L O A D   S H E D   A U X .           H E A T E R

P 1 1 3   P R O G R A M M A B L E   I N P U T
O V E R R I D E   A U X .           H E A T E R

```

Enable exchanger frost protection:

```

P 1 1 5   E X C H   F R O S T   P R O T E C .
E N A B L E D                               Y E S

```

Link with Drycooler controller:

```

P 1 1 6   L I N K   W I T H
D R Y C O O L E R                           Y E S

```

Operating mode:

```

P 1 1 9   O P E R A T I O N
                                           C O O L I N G

P 1 1 9   O P E R A T I O N
                                           H E A T I N G

P 1 1 9   O P E R A T I O N
      H T G / C L G   V I A   C O N S O L E

P 1 1 9   O P E R A T I O N
      C L G / H T G   V I A   O N / O F F

P 1 1 9   O P E R A T I O N
A U T O   C L G / H T G / O U T   T E M P .

```

Number of setpoints:

```

P 1 2 0   N O .   O F   S E T P O I N T S
                                           1

P 1 2 0   N O .   O F   S E T P O I N T S
      2   V I A   C O N S O L E   O R   B M S

P 1 2 0   N O .   O F   S E T P O I N T S
      2   V I A   O N / O F F   I N P U T

P 1 2 0   N O .   O F   S E T P O I N T S
      V I A   4 - 2 0   M A   I N P U T

```

Cooling setpoint 1:

```
P 1 2 1   C O O L I N G   S E T P O I N T   1
                                     - x x . x °
```

Cooling setpoint 2:

```
P 1 2 2   C O O L I N G   S E T P O I N T   2
                                     - x x . x °
```

Heating setpoint 1:

```
P 1 2 3   H E A T I N G   S E T P O I N T   1
                                     - x x . x °
```

Heating setpoint 2:

```
P 1 2 4   H E A T I N G   S E T P O I N T   2
                                     - x x . x °
```

Adjustment of the cooling setpoint based on the outdoor temperature:

```
P 1 2 7   C O O L I N G   S T P   B A S E D
O N ( T e x t )                               Y E S

P 1 2 7   C O O L I N G   S T P   B A S E D
O N ( T e x t )                               N O
```

Start of drift in cooling mode:

```
P 1 2 8   D R I F T   S T A R T
C O O L I N G                                 x x °
```

End of drift in cooling mode:

```
P 1 2 9   D R I F T   E N D
C O O L I N G                                 x x °
```

Maximum setpoint at end of drift in cooling mode:

```
P 1 3 0   M A X   S T P   A T   D R I F T
E N D   C O O L I N G                         x x °
```

Adjustment of the heating setpoint based on outdoor the temperature:

```
P 1 3 1   H E A T I N G   S T P   B A S E D
O N ( T e x t )                               Y E S

P 1 3 1   H E A T I N G   S T P   B A S E D
O N ( T e x t )                               N O
```

Start of drift in heating mode:

```
P 1 3 2   D R I F T   S T A R T
H E A T I N G                                 x x °
```

End of drift in heating mode:

```
P 1 3 3   D R I F T   E N D
H E A T I N G                                 x x °
```

End of drift setpoint in heating mode:

```
P 1 3 4   M A X   S T P   A T   D R I F T
E N D   H E A T I N G                         x x °
```

Control mode:

<b>P 1 4 1</b>	REGULATION TYPE	
	ON INLET	
<b>P 1 4 1</b>	REGULATION TYPE	
	ON	
	OUTLET	
<b>P 1 4 1</b>	REGULATION TYPE	
	ON	
	OUTLET + COMPENSATION	

Water supply control with compensation by water return }

Water loop winter protection:

<b>P 1 4 2</b>	WATER LOOP WINTER PROTECTION	YES
<b>P 1 4 2</b>	WATER LOOP WINTER PROTECTION	NO

•Return and supply control:

Stage differential:

<b>P 1 4 3</b>	STAGE DIFFERENTIAL	x . x K
----------------	--------------------	---------

Interstage differential:

<b>P 1 4 4</b>	INTERSTAGE DIFFERENTIAL	x . x K
----------------	-------------------------	---------

Proportional coefficient:

<b>P 1 4 5</b>	P . COEFFICIENT	x . x
----------------	-----------------	-------

Integral coefficient:

<b>P 1 4 6</b>	I . COEFFICIENT	x . x
----------------	-----------------	-------

Derivative coefficient:

<b>P 1 4 7</b>	D . COEFFICIENT	x . x
----------------	-----------------	-------

Time coefficient:

<b>P 1 4 8</b>	T . COEFFICIENT	x x x S
----------------	-----------------	---------

Control with compensation:

<b>P 1 5 0</b>	COMPENSATION COEFFICIENT	x . x
----------------	--------------------------	-------

<b>P 1 5 1</b>	COMPENSATION TIME	x x x S
----------------	-------------------	---------

Storage control:

<b>P 1 5 4</b>	STORAGE CONTROL	YES
<b>P 1 5 4</b>	STORAGE CONTROL	NO

P 1 5 5 S T O R A G E C T R L  
D I F F E R E N T I A L x . x K

• Defrosting:

Temperature at start of defrosting:

P 1 5 7 T E M P E R A T U R E S T A R T  
D E F R O S T I N G - x x . x °

Temperature at end of defrosting:

P 1 5 8 T E M P E R A T U R E E N D  
D E F R O S T I N G - x x . x °

Frosting type:

P 1 5 9 F R O S T I N G T Y P E  
F I X E D T I M E  
P 1 5 9 F R O S T I N G T Y P E  
O P T I M I S E D

Frosting cycle time:

P 1 6 0 F R O S T I N G T I M E  
F I X E D x x m n

Frosting factor:

P 1 6 1 F R O S T I N G  
F A C T O R 0 . 3

Correction with respect to the reference outdoor temperature during optimised frosting:

P 1 6 2 C O R R E C T I O N T O R E F  
O U T D O O R T E M P 0 . 2

Time delay for turning off the compressors during defrosting:

P 1 6 3 C O M P O F F T I M E D E L A Y  
D U R I N G D E F R O S T x x x S

Differential for turning on the fans during defrosting:

P 1 6 4 H P O N D I F F  
D E F R O S T I N G x x . x b

Differential for shutting off the fans during defrosting:

P 1 6 5 H P O F F D I F F  
D E F R O S T I N G x x . x b

Charge limit function:

P 1 7 1 M A X W A T E R T E M P .  
S T A G E 2 L O A D S H E D - x x . x °

Load shedding via ON/OFF input:

P 1 7 5 T Y P E O F L O A D S H E D .  
V I A O N / O F F I N P U T A U T O  
P 1 7 5 T Y P E O F L O A D S H E D  
V I A O N / O F F I N P U T . S E L E C T .

•Fan control:

Number of fan stages:

P 1 8 0 NO . OF HP CTRL  
STAGES / CIRCUIT X

HP control setpoint:

P 1 8 1 HP CONTROL  
SETPOINT xx . xb

Outdoor air temperature, forced fan operation:

P 1 8 2 OUT . AIR TEMP .  
FORCED FANS xx . x°

Fan stage differential:

P 1 8 3 HP CTRL STAGE  
DIFFERENTIAL xx . xb

Fan interstage differential:

P 1 8 4 HP CTRL INTERSTAGE  
DIFFERENTIAL xx . xb

•High Pressure control:

Low Noise operation:

P 1 9 1 LOW NOISE  
OPERATION YES  
P 1 9 1 LOW NOISE  
OPERATION NO

Maximum fan speed threshold:

P 1 9 2 MAX . FAN SPEED  
THRESHOLD xx . xV

Shifting of HP setpoint during recovery:

P 1 9 3 HP STP SHIFT  
RECOVERY xx . xb

Differential used to reduce power before cutting off the HP:

P 1 9 5 HP DIFF . FOR  
POWER REDUC . x . xb

Differential used to return to normal condensing pressure control:

P 1 9 6 HP DIFF . HP RETURN  
COND PRESS CTRL x . xb

Value at 0 V:

P 1 9 7 OUTPUT LINK TO P 2 6  
VALUE AT 0 V xx . xb

Value at 10 V:

P 1 9 8 OUTPUT LINK TO P 2 6  
VALUE AT 10 V xx . xb

Outdoor temperature at which the heating elements are turned on:

P 2 2 0 OUT . TEMPERATURE  
WINTER PROTEC . - xx . x°

Differential used to shut off these heating elements:

<b>P 2 2 2</b>	OUT . TEMP . DIFF .	
W I N T E R	P R O T E C .	- x x . x °

Minimum air temperature for operation in heating mode:

<b>P 2 2 5</b>	MIN . AIR TEMP . IN	
H E A T I N G	M O D E	- x x °

Maximum air temperature for operation in cooling mode:

<b>P 2 2 5 . 1</b>	MAX . AIR TEMP . IN	
C O O L I N G	M O D E	- x x °

Maximum air temperature for operation in heating mode

<b>P 2 2 5 . 2</b>	MAX . AIR TEMP .	
I N H E A T I N G	M O D E	- x x °

Minimum air temperature for operation in cooling mode

<b>P 2 2 5 . 3</b>	MIN . AIR TEMP .	
I N C O O L I N G	M O D E	- x x °

Air temperature at which the electric auxiliary heaters or boiler may be turned on:

<b>P 2 2 6</b>	OUT . TEMP .	
A U X I L .	A U T H . O N	- x x °

Authorisation for compressor stages to turn on:

Same when 'No' }

<b>P 2 3 0</b>	S T A G E 1	C I R C U I T 1	
O N			Y E S
<b>P 2 3 1</b>	S T A G E 2	C I R C U I T 1	
O N			Y E S
<b>P 2 3 2</b>	S T A G E 1	C I R C U I T 2	
O N			Y E S
<b>P 2 3 3</b>	S T A G E 2	C I R C U I T 2	
O N			Y E S

Authorisation for electric stages to turn on:

Same when 'No' }

<b>P 2 3 5</b>	E L E C T R I C	S T A G E 1	
O N			Y E S
<b>P 2 3 6</b>	E L E C T R I C	S T A G E 2	
O N			Y E S
<b>P 2 3 7</b>	E L E C T R I C	S T A G E 3	
O N			Y E S
<b>P 2 3 8</b>	E L E C T R I C	S T A G E 4	
O N			Y E S

Electronic expansion valve:

<b>P 6 0 1</b>	C I R C U I T 1	
V A L V E	T Y P E	E X 4

<b>P 6 0 2</b>	C I R C U I T 1	
S U P E R H E A T	S T P	6 ° C

<b>P 6 0 3</b>	C I R C U I T 1	
M O P	P O I N T	Y E S

P 6 0 4	C I R C U I T	1	M O P	V A L U E	1 5 ° C		
P 6 0 5	% O P N G	C 1	E X V	S T A R T	A I R	C O N	X X X %
P 6 0 6	% O P N G	C 1	E X V	S T A R T	H E A T	P U M P	X X X %
P 6 0 7	O P E N I N G	T I M E	S T A R T - U P	C 1	X X S		
P 6 0 8	C I R C U I T	1	S L O W	M O D E	N O		
P 6 1 1	C I R C U I T	2	V A L V E	T Y P E	E X 4		
P 6 1 2	C I R C U I T	2	S U P E R H E A T	S T P	6 ° C		
P 6 1 3	C I R C U I T	2	M O P	P O I N T	Y E S		
P 6 1 4	C I R C U I T	2	M O P	V A L U E	1 5 ° C		
P 6 1 5	% O P N G	C 2	E X V	S T A R T	A I R	C O N	X X X %
P 6 1 6	% O P N G	C 2	E X V	S T A R T	H E A T	P U M P	X X X %
P 6 1 7	O P E N I N G	T I M E	S T A R T - U P	C 2	X X S		
P 6 1 8	C I R C U I T	2	S L O W	M O D E	N O		

• Communication:

Control type:

P 1 0 3	C O N T R O L	T Y P E	L O C A L
P 1 0 3	C O N T R O L	T Y P E	R E M O T E ( B M S , e t c . )

Communication protocol:

P 7 0 0	C O M M U N I C A T I O N	
P R O T O C O L	B U S	M O D E

Transmission speed:

P 7 0 1	T R A N S M I S S I O N	
S P E E D	4 8 0 0	b a u d s

Parity:

P 7 0 2	P A R I T Y	W I T H O U T
---------	-------------	---------------



Number of stop bits:

P 7 0 3	N U M B E R   O F   S T O P	
B I T S		1

Format of real numbers:

P 7 0 4	S W A P P E D   R E A L   N U M B E R	
F O R M A T		Y E S

Bus number:

P 7 0 5	B U S   N U M B E R	
		0 0 0

•Master/slave configuration:

P 8 0 0	M A S T E R   M A C H I N E	
O N   L O O P		Y E S

P 8 0 1	B A C K U P	
M A C H I N E		Y E S

P 8 0 2	S W I T C H   B A C K U P	
M A C H I N E		Y E S

P 8 0 3	B A C K U P   M A C H I N E	
N A M E		S L A V E

P 8 0 4	L O O P   C O N T R O L	
T Y P E		P A R A L L E L

P 8 0 5	M A C H I N E	
D I F F E R E N T I A L		x x . x °

P 8 0 6	D I F F E R E N T I A L	
B T W N   M A C H I N E S		x x . x °

P 8 0 7	M A X .   D I F F .	
A D D I T I O N A L   M A C H .		x x °

P 8 0 8	T I M E   D E L A Y	
B T W N   M A C H I N E S		x x m n x x

P 8 0 9	A U T H O R I S E	
M A C H I N E   1   O N		Y E S

P 8 1 0	A U T H O R I S E	
M A C H I N E   2   O N		Y E S

### 8.7 OPERATION PARAMETERS menu

To access the OPERATION PARAMETERS menu, use the + or – buttons to position the cursor on 6 then press **OK**. The display shows the list of operation parameters.

Example:

P x x x	E X C H . 1   I N L E T   W A T E R	
T E M P .		1 2 . 5 °

Pressing on the + and – buttons scrolls through the parameters two lines at a time. The values of these parameters cannot be changed. To return to the main menu, press the **ESC** button repeatedly.

6 - R E A D I N G . P A R A M E T E R S
---

LED test: used to turn on the console LEDs corresponding to the machine configuration:

<b>P 2 5 0</b> L E D T E S T
------------------------------

Control setpoint:

<b>P 2 5 1</b> C O N T R O L S E T P O I N T	x x . x °
---	-----------

Outdoor air temperature:

<b>P 2 5 2</b> O U T D O O R A I R T E M P E R A T U R E	x x . x °
---	-----------

Water inlet temperature in heat exchanger on circuit 1:

<b>P 2 5 5</b> E X C H . 1 W A T E R I N L E T T E M P .	x x . x °
---	-----------

Water outlet temperature in heat exchanger on circuit 1:

<b>P 2 5 6</b> E X C H . 1 W A T E R O U T L E T T E M P .	x x . x °
---	-----------

Hot water temperature at condenser inlet (water-to-water unit):

<b>P 2 5 7</b> W A T E R T E M P E R A T U R E C O N D E N S E R I N L E T	x x . x °
---	-----------

Hot water temperature at condenser outlet (water-to-water unit):

<b>P 2 5 8</b> W A T E R T E M P E R A T U R E C O N D E N S E R O U T L E T	x x . x °
---	-----------

Circuit 1 coil temperature:

<b>P 2 5 9</b> C I R C . 1 C O I L T E M P . A : - x x . x ° B : - x x . x ° C : - x x . x ° D : - x x . x °
--

Circuit 1 coil temperature where P14 = 1:

<b>P 2 5 9</b> C I R C . 1 C O I L T E M P . - x x . x °
---

Refrigerant temperature on circuit 1 heat exchanger:

<b>P 2 6 0</b> E X C H . 1 R E F R . T E M P .	- x x . x °
---	-------------

Water temperature measured on manifold (case of two heat exchangers):

<b>P 2 6 1</b> M A N I F O L D W A T E R O U T L E T T E M P .	- x x . x °
---	-------------

Water outlet temperature on circuit 2 heat exchanger:

<b>P 2 6 2</b> E X C H . 2 W A T E R O U T L E T T E M P .	- x x . x °
---	-------------

Circuit 2 coil temperature:

<b>P 2 6 3</b> C I R C . 2 C O I L T E M P . A : - x x . x ° B : - x x . x ° C : - x x . x ° D : - x x . x °
--

Refrigerant temperature on circuit 2 heat exchanger:

P 2 6 4 E X C H . 2  
R E F R . T E M P . - x x . x °

Ambient temperature of heat exchanger:

P 2 6 5 E X C H A N G E R  
A M B I E N T T E M P . - x x . x °

Calculated frosting time, circuit 1:

P 2 6 6 C A L C U L A T E D F R O S T .  
T I M E C I R C U I T 1 x x m n

Calculated frosting time, circuit 2:

P 2 6 7 C A L C U L A T E D F R O S T .  
T I M E C I R C U I T 2 x x m n

Value of referenced Delta-T for optimised defrosting on circuit 1:

P 2 6 8 O P T I D E F R O S T I N G C 1  
D T R E F = x x . x ° D T D = x x . x °

Value of referenced Delta-T for optimised defrosting on circuit 2:

P 2 6 9 O P T I D E F R O S T I N G C 2  
D T R E F = x x . x ° D T D = x x . x °

Control time delay:

P 2 7 0 C O N T R O L L E R  
T I M E D E L A Y x x x s

Heating mode runtime (in hours):

P 2 8 5 H E A T I N G M O D E  
R U N T I M E x x x x x x H

Cooling mode runtime (in hours):

P 2 8 6 C O O L I N G M O D E  
R U N T I M E x x x x x x H

Pump 1 runtime (in hours):

P 2 8 7 P U M P 1  
R U N T I M E x x x x x x H

Pump 2 runtime (in hours):

P 2 8 8 P U M P 2  
R U N T I M E x x x x x x H

Number of times P99 set to 'No':

P 2 8 9 N O . T I M E S P 9 9  
S E T T O ' N O ' x x x x x x

Number of water flow cut-offs in 1 hour:

P 2 9 0 N O . W A T E R F L O W  
C U T S I N 1 H x

●Circuit 1 information:

Circuit 1 High Pressure value:

<b>P 3 0 0</b> H P 1 P R E S S U R E x x . x b
---

Value of calculated High Pressure control setpoint:

<b>P 3 0 0 . 1</b> H P 1 C O N T R O L S E T P O I N T x x . x b
---

Circuit 1 condensing temperature value resulting from the previous pressure level and the refrigerant selected:

<b>P 3 0 1</b> C I R C U I T 1 C O N D . T E M P . x x . x °
---

Stage 1, circuit 1 discharge temperature value:

<b>P 3 0 2 . 1</b> D I S C H A R G E T E M P E R A T U R E 1 x x x °
---

Stage 2, circuit 1 discharge temperature value:

<b>P 3 0 2 . 2</b> D I S C H A R G E T E M P E R A T U R E 2 x x x °
---

Desuperheat temperature on discharge 1 (= discharge temperature – condensation dew point temperature)

<b>P 3 0 3 . 1</b> D I S C H A R G E 1 D E S U P E R H E A T x x . x °
---

Desuperheat temperature on discharge 2 (= discharge temperature – condensation dew point temperature)

<b>P 3 0 3 . 2</b> D I S C H A R G E 2 D E S U P E R H E A T x x . x °
---

Circuit 1 Low Pressure value:

<b>P 3 0 4</b> L P 1 P R E S S U R E x x . x b
---

Circuit 1 evaporating temperature value resulting from the previous pressure value and the refrigerant selected:

<b>P 3 0 5</b> C I R C U I T 1 E V A P . T E M P . x x x . x °
---

Circuit 1 suction temperature value:

<b>P 3 0 6</b> C I R C U I T 1 S U C T I O N T E M P . x x x . x °
---

Circuit 1 superheat temperature:

<b>P 3 0 7</b> C I R C U I T 1 S U P E R H E A T x x x . x °
---

Number of cut-offs caused by a High Pressure fault on circuit 1 in 24 hours:

<b>P 3 0 8</b> N O . H P 1 C U T S I N 2 4 H O U R S x
---

Number of cut-offs caused by a Low Pressure fault on circuit 1 in 24 hours:

<b>P 3 0 9</b> N O . L P 1 C U T S I N 2 4 H O U R S x
---

Number of times stage 1 on circuit 1 turned on:

P 3 1 0 N O . S T A R T S  
S T A G E 1 C I R C U I T 1 x x x x x

Runtime of stage 1 on circuit 1:

P 3 1 1 S T A G E 1 C I R C U I T 1  
R U N T I M E x x x x x H

Short-cycle protection on stage 1 of circuit 1:

P 3 1 2 S T A G E 1 C I R C U I T 1  
S C P x x m n x x S

Number of times stage 2 on circuit 1 turned on:

P 3 1 3 N O . S T A R T S  
S T A G E 2 C I R C U I T 1 x x x x x

Runtime of stage 2 on circuit 1:

P 3 1 4 S T A G E 2 C I R C U I T 1  
R U N T I M E x x x x x H

Short-cycle protection on stage 2 of circuit 1:

P 3 1 5 S T A G E 2 , C I R C U I T 1  
S C P x x m n x x S

Number of cut-offs caused by frost protection on circuit 1 water line in 24 hours:

P 3 2 2 N O . H 2 O F R O S T P R O T  
C U T S C I R C 1 x

Number of cut-offs caused by frost protection on circuit 1 refrigerant line in 24 hours:

P 3 2 3 N O F R O S T P R O T  
C U T S  
C 1 R E F R I G x

Number of cut-offs caused by discharge temperature on stage 1 in 24 hours:

P 3 2 4 . 1 N O . D I S C H A R G E 1  
C U T S I N 2 4 H X

Number of cut-offs caused by discharge temperature on stage 2 in 24 hours:

P 3 2 4 . 2 N O . D I S C H A R G E 2  
C U T S I N 2 4 H X

Percentage of opening for the electronic expansion valve on circuit 1:

P 3 2 5 C 1 E X V  
O P E N I N G X X X %

Circuit 1 liquid temperature:

P 3 2 6 C I R C U I T 1  
L I Q U I D T E M P . x x . x °

Circuit 1 subcooling value:

P 3 2 7 C I R C U I T 1  
S U B C O O L I N G x x . x °

Number of cut-offs caused by circuit 1 expansion valve fault:

P 3 2 8 N O . C U T O F F S C A U S E D  
B Y C 1 E X V I N 2 4 H X

•Circuit 2 information:

Circuit 2 High Pressure value:

P 3 3 0 H P 2 P R E S S U R E  
x x . x b

Value of calculated HP control setpoint:

P 3 3 0 . 1 H P 2 C O N T R O L  
S E T P O I N T x x . x b

Circuit 2 condensing temperature value resulting from the previous pressure value and the refrigerant selected:

P 3 3 1 C I R C U I T 2  
C O N D . T E M P . x x . x °

Stage 1, circuit 2 discharge temperature value:

P 3 3 2 . 1 D I S C H A R G E  
T E M P E R A T U R E 2 x x x °

P 3 3 2 . 1 D I S C H A R G E  
T E M P E R A T U R E 3 x x x °

Stage 2, circuit 2 discharge temperature value:

P 3 3 2 . 2 D I S C H A R G E  
T E M P E R A T U R E 4 x x x °

Desuperheat temperature on circuit 2 stage 1 discharge (= discharge temperature – condensation dew point temperature)

P 3 3 3 . 1 D I S C H A R G E 2  
D E S U P E R H E A T x x . x °

P 3 3 3 . 1 D I S C H A R G E 3  
D E S U P E R H E A T x x . x °

Desuperheat temperature on circuit 2 stage 2 discharge (= discharge temperature – condensation dew point temperature)

P 3 3 3 . 2 D I S C H A R G E 4  
D E S U P E R H E A T x x . x °

Circuit 2 Low Pressure value:

P 3 3 4 L P 2 P R E S S U R E  
x x . x b

Circuit 2 evaporating temperature value resulting from the previous pressure value and the refrigerant selected:

P 3 3 5 C I R C U I T 2  
E V A P . T E M P . x x x . x °

Circuit 2 suction temperature value:

P 3 3 6 C I R C U I T 2  
S U C T I O N T E M P . x x x . x °

Circuit 2 superheat temperature:

P 3 3 7 C I R C U I T 2  
S U P E R H E A T x x x . x °

Number of cut-offs caused by a High Pressure fault on circuit 2 in 24 hours:

<b>P 3 3 8</b> NO . H P 2 C U T S I N 2 4 H O U R S	x
--	---

Number of cut-offs caused by a Low Pressure fault on circuit 2 in 24 hours:

<b>P 3 3 9</b> NO . L P 2 C U T S I N 2 4 H O U R S	x
--	---

Number of times stage 1 on circuit 2 turned on:

<b>P 3 4 0</b> NO . S T A R T S S T A G E 1 C I R C U I T 2	x x x x x
--	-----------

Runtime of stage 1 on circuit 2:

<b>P 3 4 1</b> S T A G E 1 C I R C U I T 2 R U N T I M E	x x x x x H
---	-------------

Short-cycle protection on stage 1 of circuit 2:

<b>P 3 4 2</b> S T A G E 1 , C I R C U I T 2 S C P	x x m n x x S
---	---------------

Number of times stage 2 on circuit 2 turned on:

<b>P 3 4 3</b> NO . S T A R T S S T A G E 2 C I R C U I T 2	x x x x x
--	-----------

Runtime of stage 2 on circuit 2:

<b>P 3 4 4</b> S T A G E 2 C I R C U I T 2 R U N T I M E	x x x x x H
---	-------------

Short-cycle protection on stage 2 of circuit 2:

<b>P 3 4 5</b> S T A G E 2 , C I R C U I T 2 S C P	x x m n x x S
---	---------------

Number of cut-offs caused by frost protection on circuit 2 water line in 24 hours:

<b>P 3 5 2</b> NO . H 2 O F R O S T P R O T C U T S C I R C 2	x
---	---

Number of cut-offs caused by frost protection on circuit 2 refrigerant line in 24 hours:

<b>P 3 5 3</b> NO F R O S T P R O T C U T S C 2 R E F R I G	x
---	---

Number of cut-offs caused by discharge temperature on stage 1 of circuit 2 in 24 hours:

<b>P 3 5 4 . 1</b> NO . D I S C H A R G E 2 C U T S I N 2 4 H	X
--	---

<b>P 3 5 4 . 1</b> NO . D I S C H A R G E 3 C U T S I N 2 4 H	X
--	---

Number of cut-offs caused by discharge temperature on stage 2 of circuit 2 in 24 hours:

<b>P 3 5 4 . 2</b> NO . D I S C H A R G E 4 C U T S I N 2 4 H	X
--	---

Percentage of opening for the electronic expansion valve on circuit 2:

<b>P 3 5 5</b> C 2 E X V O P E N I N G	X X X %
---	---------

Circuit 2 liquid temperature:

P 3 5 6 C I R C U I T 2  
L I Q U I D T E M P . x x . x °

Circuit 2 subcooling value:

P 3 5 7 C I R C U I T 2  
S U B C O O L I N G x x . x °

Number of cut-offs caused by circuit 2 expansion valve fault:

P 3 5 8 N O . C U T O F F S C A U S E D  
B Y C 2 E X V I N 2 4 H X

• Inputs:

State of unit automatic operation control input:

P 4 0 0 A U T O . O P E R A T I O N  
C T R L I N P U T O P E N

State of setpoint selection input (1 or 2):

P 4 0 2 S E T P O I N T S E L E C T I O N  
I N P U T 1

State of water flow fault input:

P 4 0 3 W A T E R F L O W  
F A U L T I N P U T O P E N

} Same when 'CLOSED'

State of fan fault input:

P 4 0 4 F A N F A U L T  
I N P U T O P E N

State of operating mode selection input:

P 4 0 5 H E A T I N G / C O O L I N G  
M O D E I N P U T O P E N

State of phase controller fault input:

P 4 0 6 P H A S E C O N T R O L L E R  
F A U L T I N P U T O P E N

State of recovery operating mode selection input:

P 4 0 7 R E C O V E R Y  
O P E R A T I O N  
I N P U T O P E N

State of fault input 1 on Additional board 1 for units equipped with auxiliary electric heaters P22 = Yes:

P 4 0 8 F A U L T I N P U T 1  
E L E C T R I C A D D 1 O P E N

State of fault input 2 on Additional board 1 for units equipped with auxiliary electric heaters P22 = Yes:

P 4 0 9 F A U L T I N P U T 2  
E L E C T R I C A D D 1 O P E N

State of configurable input on additional board 1 for units equipped with auxiliary electric heaters P22 = Yes and P113 = load shedding or forced:

P 4 1 0 C O N F I G U R A B L E I N P U T  
E L E C T R I C A D D 1 O P E N



State of stage 1 override input:

<b>P 4 1 4</b> S T A G E 1 O V E R R I D E
I N P U T O P E N

State of stage 2 override input:

<b>P 4 1 5</b> S T A G E 2 O V E R R I D E
I N P U T O P E N

State of stage 3 override input:

<b>P 4 1 6</b> S T A G E 3 O V E R R I D E
I N P U T O P E N

State of stage 4 override input:

<b>P 4 1 7</b> S T A G E 4 O V E R R I D E
I N P U T O P E N

State of manual High Pressure switch input on circuit 1:

<b>P 4 1 8</b> M A N U A L H P 1
F A U L T I N P U T O P E N

State of stage 1, circuit 1 fault input:

<b>P 4 1 9</b> S T A G E 1 C I R C U I T 1
F A U L T I N P U T O P E N

State of stage 2, circuit 1 fault input:

<b>P 4 2 0</b> S T A G E 2 C I R C U I T 1
F A U L T I N P U T O P E N

State of manual High Pressure switch input on circuit 2:

<b>P 4 2 2</b> M A N U A L H P 2
F A U L T I N P U T O P E N

State of stage 1, circuit 2 fault input:

<b>P 4 2 3</b> S T A G E 1 C I R C U I T 2
F A U L T I N P U T O P E N

State of stage 2, circuit 2 fault input:

<b>P 4 2 4</b> S T A G E 2 C I R C U I T 2
F A U L T I N P U T O P E N

State of fault input for electronic expansion valve on circuit 1:

<b>P 4 2 5</b> C I R C 1 E X V
F A U L T I N P U T O P E N

State of fault input for electronic expansion valve on circuit 2:

<b>P 4 2 6</b> C I R C 2 E X V
F A U L T I N P U T O P E N

• **Outputs:**

Pump 1 contact:

<b>P 4 3 0</b> P U M P 1 O U T P U T
O N

Pump 2 contact:

P 4 3 1 P U M P 2 O U T P U T  
O N

Circuit 1 Y/C contact:

P 4 3 2 C I R C U I T 1  
Y / C O U T P U T O N

Circuit 2 Y/C contact:

P 4 3 3 C I R C U I T 2  
Y / C O U T P U T O N

Heat trace cable contact:

P 4 3 5 H E A T T R A C E  
O N

Heater contact:

P 4 3 6 H E A T E R  
O U T P U T O N

Contact for frost protection heat trace cable (recovery option):

P 4 3 7 R E C O V E R Y F R O S T  
P R O T . O U T P U T O N

Configurable output contact:

P 4 3 8 M A X I M U M  
P O W E R O U T P U T O N

P 4 3 9 B O I L E R O U T P U T  
O F F

P 4 4 0 C L G / H T G R E P O R T  
O U T P U T O F F

Control contact for fan stages if P180 = 1:

P 4 4 1 F A N O F F  
O N  
H S  
L S

HS (High Speed) =high temperature  
LS = Low Speed

Control contact for fan stages P180 = 2 (2 stages) and P3 = 1 (1 circuit)

P 4 4 1 H P C O N T R O L  
S T A G E 1 O U T P U T O N

P 4 4 2 H P C O N T R O L  
S T A G E 2 O U T P U T O N

Control contact for fan stages P180 = 2 (2 stages) and P3 = 2 (2 circuits):

P 4 4 1 H P C O N T R O L  
S T A G E 1 C 1 O U T P U T O N

P 4 4 2 H P C O N T R O L  
S T A G E 2 C 1 O U T P U T O N

P 4 4 3 H P C O N T R O L  
S T A G E 1 C 2 O U T P U T O N

P 4 4 4 H P C O N T R O L  
S T A G E 2 C 2 O U T P U T O N

Control contact for fan stages P180 = 3 (3 stages) and P3 = 2 (2 circuits) and P11 = split  
P441, P442, P443 and P444 same as P180 = 2 (2 stages) and P3 = 2 (2 circuits):

<b>P 4 4 5</b>	H P	C O N T R O L	
S T A G E	3	C 1 O U T P U T	O N

<b>P 4 4 6</b>	H P	C O N T R O L	
S T A G E	3	C 2 O U T P U T	O N

Control contact for fan stages P180 = 3 (3 stages) and P3 = 2 (2 circuits) and P11 = mixed  
P441, P442, P443 and P444 same as P180 = 2 (2 stages) and P3 = 2 (2 circuits):

<b>P 4 4 5</b>	H P	C O N T R O L	
C O M S T A G E	1	O U T P U T	
O N			

<b>P 4 4 6</b>	H P	C O N T R O L	
C O M S T A G E	3	O U T P U T	
O N			

Speed control information (intertwined coil):

<b>P 4 4 7</b>	H P	S T A G E	1	
D R I V I N G	V O L T A G E			X X . X V

Speed control information (split or mixed coil), stage 1, circuit 1:

<b>P 4 4 8</b>	H P	S T A G E	1	C 1
D R I V I N G	V O L T A G E			X X . X V

Speed control information (split or mixed coil), stage 1, circuit 2:

<b>P 4 4 9</b>	H P	S T A G E	1	C 2
D R I V I N G	V O L T A G E			X X . X V

Speed control information (mixed coil), common stage 1:

<b>P 4 5 0</b>	H P	C O M S T A G E	1
D R I V I N G	V O L T A G E		X X . X V

Circuit 1 balance valve output contact:

<b>P 4 5 1</b>	C 1	B A L A N C E	V A L V E
O U T P U T			O N

Circuit 2 balance valve output contact:

<b>P 4 5 2</b>	C 2	B A L A N C E	V A L V E
O U T P U T			O N

Electric stage output:

<b>P 5 3 x</b>	E L E C T R I C	S T A G E	x
O U T P U T			O N

Air blade information:

<b>P 5 3 5</b>	A I R	B L A D E	
O P E N I N G	%		x x x %

Stages 1 to 4

Version:

<b>P 5 5 5</b>	C P U	V E R S I O N	N O .
			x x - x x

<b>P 5 5 6</b>	C O N S O L E	V E R S I O N	
N O .			x x - x x

<b>P 5 5 7</b>	C I R C U I T	2	B O A R D
V E R S I O N	N O .		x x - x x

<b>P 5 5 8</b>	R E V E R S A L	B O A R D	
V E R S I O N	N O .		x x - x x

P 5 5 9	A U X .	B O A R D	
V E R S I O N	N O .		x x - x x

Version number of circuit 1 electronic expansion valve:

P 5 6 0	C I R 1	E X V	V E R S I O N
N O .	X X . Y Y	V C M	X X . Y Y

Version number of circuit 2 electronic expansion valve:

P 5 6 1	C I R 2	E X V	V E R S I O N
N O .	X X . Y Y	V C M	X X . Y Y

“SO” order number:

P 5 7 0	S O	O R D E R	
N U M B E R			X X X X X X X X

MO number:

P 5 7 1	M O	N U M B E R	
			X X X X X X X X

Machine identification name:

P 5 7 2	M A C H I N E	L O C A T I O N	
	X X		

Machine identification number:

P 5 7 3	M A C H I N E	N U M B E R	
			X X X X X X X X

### 8.8 FAULT MEMORY menu

This menu records the last 20 faults on the machine and the associated values measured at the time the faults occurred. To enter the FAULT MEMORY menu, use the + or - buttons to position the cursor on 7 then press **OK**. The list of faults appears on the display. Press the + or - buttons to scroll through the faults.

•**Accessing the fault memory:**

To access measured values when a fault occurred, press **OK**.

**⚠ Measured values cannot be accessed in the event of a mains power failure.**

Press the + or - buttons to scroll through the faults line by line. To go back to the main menu, press the button **ESC** until the menu appears.

Below is the list of messages that appear in the fault memory regardless of the fault type (main circuit fault, main unit fault, temporary fault).

x - M A I N S	P O W E R	F A I L U R E	
x - P H A S E	C O N T R O L L E R		
x - W A T E R	F L O W	R A T E	
x - W A T E R	F R O S T	P R O T .	x
x - R E F R .	F R O S T	P R O T .	X
x - C P	D E L T A	P	
x - C O M P	D R I V E R		
x - C I R C U I T x	H P		
x - M A N U A L	H P	x	
x - C I R C U I T x	L P		
x - M O T O R	S T A G E x	C I R x	
x - M I N	S U P E R H E A T	C X	
x - M A X	S U P E R H E A T	C X	
x - R E F . T .		x	
x - M I N .	T E M P . /	A I R	
x - M A X .	T E M P . /	A I R	
x - F A N			
x - E X C H .	H 2 O	I N . S E N S O R	
x - E X C H . x	H 2 O	O U T . S E N S .	
x - O U T . T E M P .	S E N S O R		
x - E X C H . x	F R O S	P R O T . S E N S O	

} On refrigerant

```

x - C O N D E N S E R   I N   S E N S O R
x - C O N D E N S E R   O U T   S E N S O R
x - C I R   x   C O I L   A   S E N S O R
x - D I S C H .   S E N S O R x
x - M A N I F .   H 2 O   S E N S O R
x - E X C H .   A M B .   S E N S O R
x - S U C T I O N   S E N S O R
x - L P   S E N S O R   x
x - H P   S E N S O R   x
x - P U M P   X
x - P U M P S   1   A N D   2
x - S E L F - A D J   C T R L
x - C I R C U I T x   D E F R O S T
x - C X   E X P .   V A L V E
x - E X P .   V A L V E   X   L I N K
x - E X C H .   F R O S T   P R O T .   x
F A U L T   M E M O R Y   E M P T Y

```

Reading for saving faults to memory:

•Reading if a circuit fault occurs: information on circuit that cut off

```

H P X : x x x . x b   T C O N D : + x x . x ° ↑
L P x : x x x . x b   T E V A P : + x x . x °
S U C T I O N   T .   x : + x x . x °
S U P E R H E A T   x : x x . x ° ↓

D I S . T 1 : x x x °   D I S . T 2 : x x x ° ↑
W A T E R   I N L E T :   - x x . x °
W A T E R   O U T L E T : - x x . x °
O U T D O O R   T . : - x x . x ° ↓

R E F R I G .   T .   x   + x x . x ° ↑
H O T   W A T E R   T .   - x x . x

```

•If a unit fault occurs:

```

O U T D O O R   T . : - x x . x ° ↑
C T R L   S T P :   - x x . x °
W A T E R   I N L E T :   - x x . x °
M A N .   W A T E R   O U T : x x . x ° ↓
H O T   W A T E R   T .   - x x . x ° ↑

```

Manifold water outlets  
(if two circuits)  
or water outlet 1  
(if one circuit)

### 8.9 TEST MODE menu

TEST MODE is used to shorten time delays and eliminate limits (but keep the protections on).

The other menus (measured values, parameters, fault memory, etc.) can be accessed while in test mode.

**When test mode is on for a circuit, the Voltage LED flashes quickly (the same LED on the remote control console flashes).**

**To turn on test mode:**

➤ Via menu 8.

```

T E S T   M O D E                               Y E S
T E S T   M O D E                               N O

```

Select YES or NO with the + and - buttons. Press **OK** to confirm your choice.

**To turn off test mode:**

➤ Select NO in the submenu of menu 8 or wait 1 hour for test mode to turn off (NO) automatically.

Test mode remains on for 1 hour.

## 9 MANAGEMENT OF THE ON/OFF INPUTS

### 9.1 Automatic machine operation control

This input is used by the customer. This control allows customers to remotely prevent the machine from operating.

- The On/Off LED flashes when this control is on.
- Message on display: SHUT OFF BY MACHINE AUTO CONTROL

Contact state: closed or connected by a jumper (automatic machine operation control = Yes)

### 9.2 Load shedding control

The load shedding controls on the main board are used to turn off the stages on circuit 1.

The load shedding controls on the main board are used to turn off the stages on circuit 2.

**The stages to be shut off are selected by:**

- Balancing the runtimes (P175 = Automatic) and the number of closed inputs. Associated message: "NO. STAGES TO BE SHUT OFF".

The controller turns off the stages that have been running the longest.

- Or they can be shut off selectively (P175 = Selective): Input 1 on circuit 1 turns off stage 1 on circuit 1. Input 2 on circuit 1 turns off stage 2 on circuit 1. Input 1 on circuit 2 turns off stage 1 on

### 9.3 Water flow switch

The information is sent to an open on/off input on the water flow switch.

#### 9.3.1 Management for water-to-water units in cooling mode, air-to-water units and reversible air-to-water units

- The water flow switch is read 10 second after pump 1 or 2 is authorised to turn on if P25 = 2 and while at one of the pumps is running.

The contact must remain open for at least 3 seconds in order to

##### • If $\leq 3$ shutdowns occur in 1 hour

➤ If a fault occurs:

- Pump shut off, compressor and electric stages shut off
- 1-minute time delay (10 seconds in test mode).
- Saved in fault memory
- Machine fault output not active

➤ Display:

```
W A T E R   F L O W   F A U L T
X   C U T ( S )   I N   1 H
```

➤ Resetting: The fault is automatically acknowledged after the 1-minute time delay.

##### • If $> 3$ shutdowns occur in 1 hour

➤ If a fault occurs:

- Pumps shut off, compressor and electric stages shut off
- Saved in fault memory
- Unit fault output active

➤ Display:

```
      M A C H I N E   O F F
W A T E R   F L O W   F A U L T
```

➤ Resetting: Press the **Reset** button.

##### • If reversible air-to-water + boiler (P111 = boiler)

A) If P27 = Yes (pump controlled by boiler operation):

- If a flow switch fault occurs on the heat pump, the boiler is authorised to turn on.

B) If P27 = No (pump controlled only by on/off):

- If a flow switch fault occurs on the heat pump, the boiler is shut off.

#### 9.3.2 Management for water-to-water units in heating mode

A time delay is necessary to manage this fault.

This time delay is:

- Determined by P109 if P108 = depending on control mode
- 10 seconds if P108 = depending on On/Off.

The water flow switch is read after this time delay, after pump 2 is turned on and while pump 2 is running.

##### • If $\leq 3$ stops in 1 hour

➤ If a fault occurs:

- Pump 2 is shut off
- Thermodynamic stages shut off; auxiliary heaters may remain on
- Saved in fault memory
- Fault output off
- General fault LED on console lit steady

➤ Display:

```
W A T E R   F L O W   F A U L T
X   C U T ( S )   I N   1 H
```

➤ Resetting: The fault disappears automatically after 1 minute

circuit 2. Input 2 on circuit 2 turns off stage 2 on circuit 2, and the following message appears: "STAGE x CIRCUIT x TURNED OFF".

State of on/off contact: open at rest

These stages can also be shut off via the Modbus protocol (bits 515 to 518). Refer to the communication protocol section at the end of these instructions.

- If P175 = Selective, OR is placed between the on/off inputs and the information from the bus.

- If P175 = Automatic, the compressors will be shut off by the greatest number of inputs between the on/off inputs and the bus.

**Load shedding is cancelled if no information is sent by the bus for more than 6 hours.**

Changing the fault management mode resets the number of water flow faults.

detect a fault.

- If a water flow fault occurs during the 1-minute circulation delay (after the last control stage), it will not be managed as a fault but the pump will be shut off.

- Water flow fault relay on optional board in Off position

- General fault LED on console flashes

- Number of faults over a 1-hour period managed.

- Water flow fault relay on optional board in On position

- General fault LED on console lit steady

- Number of faults over a 1-hour period managed.

- If a water flow fault occurs during the 1-minute circulation delay (after the last control stage), it will not be managed as a fault but the pump will be shut off.

- Time delay increased by 10 seconds before water flow fault read

- The time delay value obtained is stored in memory so that it can be applied the next time the pump is turned on.

- The increased time delay is reset if P109 is changed.

**•If ≥ 3 stops in 1 hour**

- If a fault occurs:
  - Pump 2 is shut off
  - Thermodynamic stages shut off; auxiliary heaters may remain on
  - Saved in fault memory
  - Fault output on

- General fault LED on console flashes
- The time delay value obtained is stored in memory so that it can be applied the next time the pump is turned on.
- The increased time delay is reset if P109 is changed.

➤ Display:

M A C H I N E O F F  
W A T E R F L O W F A U L T

➤ Resetting: Press **Reset**

**9.4 Fan fault (circuits 1 and 2)**

Fan faults are managed in series. As a result, there is only one fan fault input. Faults are read on terminals 5-6 of terminal block J6. When P21 = Yes or P10 = Pressure, this input should not be read

until 10 seconds after the unit is turned on and IS NOT TAKEN INTO ACCOUNT WHEN THE UNIT IS SHUT OFF.

**•If P10 ≠ centrifugal:**

- If a fault occurs:
  - Machine and fans shut off by HP safety.
  - Fault saved to fault memory
  - Fan fault relay on relay board in On position

- General fault LED on console flashes
- Fault acknowledged automatically when input closed

**•Si P10 = centrifugal:**

- If a fault occurs:
  - Machine shut off because fan shut off
  - Fault saved to fault memory
  - General fault relay on relay board in On position

- General fault LED on console lit steady
- Fault acknowledged manually

➤ Display:

M A C H I N E S T A T U S  
F A N F A U L T

Saved in fault memory

X - F A N

➤ Resetting:  
When the input is closed the fault is acknowledged automatically  
Special case: a fan fault will turn off units in the LP range (air-to-

water and centrifugal fan).

**9.5 Expansion valve fault**

**•If P42 = ALCO**

This configuration corresponds to using the electronic expansion valve with the Alco driver module and display. Only fault feedback signals from the valve are managed in this case.

The fault signal contact on the electronic expansion valve on circuit 1 must be wired to terminals 5-6 on terminal block J5 on the motherboard. The contact on the valve on circuit 2 must be wired to terminals 5-6 on terminal block J2 on additional board 2 for circuit 2.

➤ Operation:  
Corresponding circuit shut off when its input opens.

**•If < 3 shutdowns occur in 24 hours**

- If a fault occurs:
  - Corresponding circuit shut off
  - Fault output on
  - Saved in fault memory

- Circuit fault LED on console flashes
- Number of faults over a 24-hour period managed.

➤ Display:

F A U L T O N E X V X  
X C U T S I N 2 4 H

**•If ≥ 3 shutdowns occur in 24 hours**

- If a fault occurs:
  - Corresponding circuit shut off
  - Fault output on
  - Saved in fault memory

- Circuit fault LED on console lit steady
- Number of faults over a 24-hour period managed.

➤ Display:

C I R C U I T X O F F  
E X P . V A L V E F A U L T

➤ Resetting:

If the number of faults in 24 hours < 3: The fault is automatically acknowledged after 120 seconds and the fault input is closed.

If the number of faults in 24 hours ≥ 3: Acknowledge by pressing **Reset** on the console and by closing the fault input.

➤ Fault memory:

F A U L T O N E X V c x

• If P42 = VCM (bus link)

**Expansion valve actuator and expansion valve board protection:**

If any of these four faults is detected on the corresponding

refrigerating circuit, the circuit is shut off and the fault is reported.

The circuit may restart when the fault disappears.

B O A R D L I N K F A U L T  
C I R C U I T 1 E X V

- Link fault in fault memory

- E X P A N S I O N V A L V E 1 L I N K

EXV actuator fault in machine status

M O T O R F A U L T  
C I R C U I T 1 E X V

EXV actuator fault in fault memory

- E X V 1 A C T U A T O R

Expansion valve VCM board fault

C I R C U I T X O F F  
E X P . V A L V E F A U L T  
F A U L T O N E X V X  
X C U T S I N 2 4 H

**9.6 Phase controller fault**

The phase controller protects the entire machine. It must be wired to terminals 7-8 on terminal block J5 on the motherboard.

The machine is shut off when a fault occurs on the phase controller (contact opens).

➤ Fault message:

M A C H I N E O F F  
P H A S E C O N T R O L L E R F A U L T

➤ If a fault occurs:

- Fault saved in fault memory
- Relay in On position

- Phase control fault relay on relay board in On position
- General fault LED on console lit steady

➤ Resetting:

The opening of the input starts a 2-minute time delay. The fault is acknowledged at the end of this period provided the contact

is closed. The input is not read during this time delay.

➤ Message in fault memory:

X - P H A S E C O N T R O L L E R

**9.7 Pump fault**

Pump faults are automatically reset. They disappear when acknowledged on the circuit breakers.

• If P25 = 0:

No pumps supplied, only pump fault 1 is managed in the same way if P25 = 1

If a pump fault occurs after the last control stage is shut off but before the pump is shut off (1 minute after), the water flow fault is not managed. Instead, the pump is shut off.



•If P25 = 1:

Only one pump supplied.

If the pump fault is detected, the unit is shut off and the following message appears:

M A C H I N E O F F  
P U M P 1 F A U L T

- Compressor and electric stages shut off
- Saved in fault memory
- Unit fault output active
- Pump 1 fault relay on optional board in On position
- General fault LED on console lit steady

•If P25 = 2 then P2 = air-to-water or reversible air-to-water: two pumps supplied

A) If a fault occurs on the pump that is on, the unit is shut off then turned back on with the other pump operating. A pump fault is reported.

P U M P X F A U L T  
B A C K U P P U M P O N

- Saved in fault memory
- Unit fault output active
- Pump 1 fault relay on optional board in On position
- General fault LED on console flashes

B) If a fault occurs on the second pump as well, the unit is shut off and the following message appears:

M A C H I N E O F F  
P U M P 1 A N D 2 F A U L T

- Saved in fault memory
- Unit fault output active
- Pump 1 fault relay on optional board in On position
- Pump 2 fault relay on optional board in On position
- General fault LED on console lit steady

C) If the machine is turned on:  
- The available pump (i.e. without a fault) is turned on and the faulty pump is reported.

### 9.8 Compressor protection

➤ Operation:

Information is received by the following open inputs:

- Terminals 1-2 on terminal block J5 on motherboard: Stage 1, circuit 1
- Terminals 2-3 on terminal block J5 on motherboard: Stage 2, circuit 1
- Terminals 1-2 on terminal block J2 on circuit 2 ADD2 board: Stage 1, circuit 2
- Terminals 2-3 on terminal block J2 on circuit 2 ADD2 board: Stage 2, circuit 2

These inputs are read 10 seconds after a mains power failure (slowness of switch INT69 causing a fault). They must be open for more than 5 seconds for the fault to be taken into account.

➤ Main circuit fault:

- Corresponding circuit shut off; fault displayed on LCD
- Circuit fault LED lit steady
- Fault stored in memory in case of a mains power failure
- Fault saved in fault memory
- Relay in On position
- Stage x fault relay on relay board in On position

This fault must be acknowledged manually and the motor fault must disappear (closed).

➤ Display:

M O T O R F A U L T  
S T A G E x C I R C U I T x

Saved in fault memory

x - M O T O R S T A G E x C I R x

➤ Resetting:

Press **Reset**

### 9.9 Manual HP pressure switch fault on circuit 1 or 2

➤ Operation:

These two inputs monitor the status of the HP pressure switches on each refrigerating circuit.

They are associated with the operation of their respective circuits. They are read 3 seconds after a stage on the circuit turns on.

➤ If a fault occurs:

- Corresponding circuit shut off.
- General fault output on
- Circuit x HP fault relay on optional board in On position
- Circuit LED on console lit steady.

➤ Display:

C I R C U I T B R E A K x  
M A N U A L H P F A U L T

Saved in fault memory

x - M A N U A L H P x

➤ Resetting:

Reset the HP switch manually then reset the fault by pressing **Reset**.

### 9.10 Setpoint selection via on/off input

If the number of setpoints = 2 with selection via on/off input (the on/off input corresponds to terminals 4-6 on terminal block J6 on the motherboard).

**• In cooling mode:**

- If the setpoint is not adjusted based on the outdoor temperature or there is a fault on the outdoor temperature sensor, the control setpoint = P121 if the on/off input is open or P122 if the on/off input is closed.

- If the setpoint is adjusted based on the outdoor temperature and there are no faults on the outdoor sensor: The setpoint is calculated using P121 if the on/off input is open. If the input is closed, the setpoint is calculated using P122.

**• In heating mode:**

- If the setpoint is not adjusted based on the outdoor temperature or there is a fault on the outdoor temperature sensor, the control setpoint = P123 if the on/off input is open or P124 if the on/off input is closed.

- If the setpoint is adjusted based on the outdoor temperature and there are no faults on the outdoor sensor: The setpoint is calculated using P123 if the on/off input is open. If the input is closed, the setpoint is calculated using P124.

### 9.11 Variable setpoint via 4-20 mA input

**• In heating mode:**

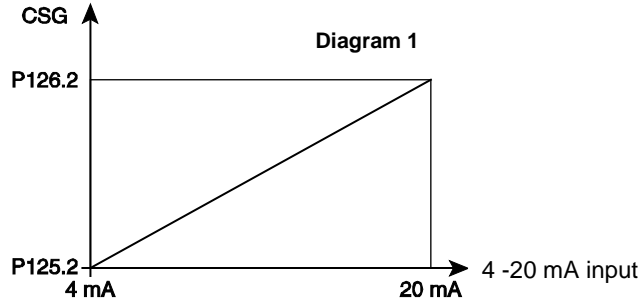

STP = Setpoint

- Displayed if P120 = 3 and in HEATING mode:

P 1 2 5 . 2	S T P	F O R	4 m A
H E A T I N G		-	X x . x °

  

P 1 2 6 . 2	S T P	F O R	2 0 m A
H E A T I N G		-	x x . x °

If setpoint adjustment based on outdoor temperature = No or there is an outdoor sensor fault → Control setpoint = result of diagram 1  
 If the setpoint is adjusted based on the outdoor temperature = Yes and there are no faults on the outdoor sensor: The derived setpoint is calculated using the outdoor temperature.

The result of diagram 1 is taken as the setpoint (P123 or P124).  
 If P120 is set to '3', P131 automatically switches to 'No'.  
 - To reverse the direction of the slope, simply set P125.2 to > P126.2 with a minimum difference of 5 K.

**•In cooling mode:**

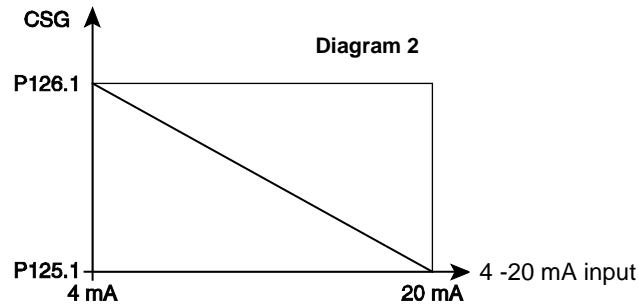

STP = Setpoint

Displayed if P120 = 3 and in cooling mode:

P 1 2 5 . 1	S T P	F O R	4 m A
C O O L I N G		-	x x . x °

P 1 2 6 . 1	S T P	F O R	2 0 m A
C O O L I N G		-	x x . x °

If setpoint adjustment based on outdoor temperature = No or there is an outdoor sensor fault → Control setpoint = result of diagram 2  
 If setpoint adjustment based on outdoor temperature = Yes and there are no faults on the outdoor sensor → The derived setpoint is calculated using the outdoor temperature. The result of diagram

2 is taken as the setpoint (P121 or P122).  
 If P120 is set to '3', P127 automatically switches to 'No'.  
 - To reverse the direction of the slope, simply set P125.1 to > P126.1 with a minimum difference of 5 K

**IMPORTANT NOTE ABOUT THIS FUNCTION:** operating problems may occur if parameters P127 and P131 are set to 'Yes' and the controller delivering the 4-20 mA signal has its own function for shifting the setpoint based on the outdoor temperature.  
 If the minimum value of the signal becomes less than 4 mA, the value of the setpoint will not drop below the minimum setpoint.

## 9.12 Operating mode selection

### • If P119 = 4 (cooling/heating via on/off input):

The unit is controlled, during water heating or water chilling, based on the mode selected via the input located:

- Between terminals 5-6 on terminal block J6 on the motherboard if P2 = water-to-water
  - Between terminals 1-2 on terminal block J4 on additional board 1 if P2 = reversible air-to-water, 1 circuit
  - Between terminals 1-2 on terminal block J2 of additional board 2 (cycle reversal) if P2 = reversible air-to-water, 2 circuits
- The contact must be closed in order to be able to select heating

mode, and it must be open in order to be able to select cooling mode.

- If P2 = water-to-water, the machine must be shut off via the On/Off button or the automatic operation control and winter protection must be shut off before the operating mode may be changed.

➤ A fault will occur if the operating mode is changed while the machine is running:

- Unit shut off,
- General fault LED on

- LED of initial mode flashes; fault control contact closed (not stored in fault memory)

M A C H I N E   O F F  
O P E R A T I N G   M O D E   C H A N G E

➤ Automatic acknowledgment:

- The operating mode changes if the change is confirmed via the On/Off button or the automatic operation control.

- If the input returns to its original state, the unit resumes its initial operating mode.

If P2 = reversible air-to-water, the operating mode may be switched with the unit running. After the operating mode is changed, the unit will stop and restart in its new operating mode and take into account the short-cycle protection.

## 10 MANAGEMENT OF THE ANALOGUE INPUTS

### 10.1 Temperature sensor

Diagram of sensors: All sensor faults are taken into account in the fault memory.

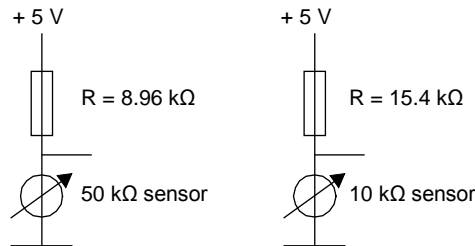

#### • Water inlet sensor: CTN 10 K at 25°C (if P2 = 1, 2 or 3)

This sensor monitors the water temperature on the exchanger inlet in order to:

- Adjust the unit (water return control).
- Monitor the operation of the unit if the water return temperature is too high (load limiting).

- Display the chilled water or hot water inlet temperature (display range: -40 to 99°C, resolution: 0.1 K).
- Automatic acknowledgement

E X C H . 1   W A T E R   I N L E T  
S E N S O R   F A U L T   J 7 / 2 - 3

- Sensor wire cut and short circuit:

➤ In cooling mode:

- Unit shut off, message on LCD, unit fault LED lit steady, fault saved in fault memory, fault relay in On position.

➤ In heating mode:

- Water-to-water unit → No effect on control, message on LCD, unit fault LED flashes, fault saved in fault memory.
- Reversible air-to-water unit and water return control → Unit shut off, message on LCD, unit fault LED lit steady, fault saved in fault

memory, fault relay in On position.

- Reversible air-to-water unit and water return control → No effect on control, message on LCD, unit fault LED flashes, fault saved in fault memory.

#### • Water outlet sensor on heat exchanger 1: CTN 10 K at 25°C (if P2 = 1, 2 or 3)

This sensor monitors the water temperature on the exchanger outlet in order to:

- Adjust the unit (to water supply) → (P6 = 1) and (P141 = 3 or 4) and cooling mode or (P02 = 3), (P6 = 1) and (P141 = 3 or 4) and heating mode
- Enable the frost protection

- Display the water outlet temperature (display range: -40 to 99.9°C, resolution: 0.1 K).
- Automatic acknowledgement

E X C H . 1   W A T E R   O U T L E T  
S E N S O R   F A U L T   J 7 / 4 - 5

- Sensor wire cut and sensor short circuit → Fault relay in On position

If this sensor is used for control, the unit is shut off (message from table 1 in machine status menu shown on LCD, unit fault LED lit steady, fault saved in fault memory). If heating mode is on: the electric auxiliary heaters are turned on if possible and the boiler relay is in the On position if P111 = boiler).

If the sensor is not used for control (i.e. it is used only for the frost limit), the fault is a circuit fault (message from circuit 1 table in machine status menu shown on LCD, circuit fault LED lit steady, fault saved in fault memory).

•**Water outlet sensor on heat exchanger 2:** CTN 10 K at 25°C (if P2 = 1, 2 or 3)(if P6 = 2 → two sensors + manifold sensors).

This sensor monitors the water temperature on the exchanger outlet in order to:

- Enable the frost protection -40 to 99.9°C, resolution: 0.1 K).
- Display the water outlet temperature (display range: - Automatic acknowledgement

E X C H . 2 W A T E R O U T L E T  
S E N S O R F A U L T A D D 2 J 4 / 1 -  
2

- Sensor wire cut and sensor short circuit → Fault relay in On position

This sensor is not used for control (i.e. it is used only for frost protection; control is provided by the manifold sensor). The fault is

a circuit fault (message on LCD, circuit fault LED lit steady, fault saved in fault memory).

•**Outdoor air sensor:** CTN 10 K at 25°C

This sensor monitors the temperature of the outdoor air in order to:

- Adjust the system based on the outdoor temperature (cooling and heating). If the sensor wire is cut (open circuit) or the sensor short-circuits, the unit is adjusted to the setpoint value (heating and cooling) and a fault is displayed.
- Limit the operation of the unit based on the minimum temperature

in heating mode.

- Display the outdoor air temperature (display range: -40 to 99.9°C, resolution: 0.1 K).
- Automatic acknowledgement

O U T . T E M P . S E N S O R F A U L T  
J 7 / 1 - 2

- Sensor wire cut and short circuit:
- . Control based on outdoor temperature inhibited; control using setpoint.
- . If the unit is running in heating mode and can run with the electric stages, the compressors are shut off, control is on the electric stages, a message appears on the LCD, the unit fault LED flashes, and the fault is saved in fault memory.

- . If P2 = water-to-water, the unit continues to operate and the fault is reported (message from table 2 in machine status menu shown on LCD, unit fault LED flashes, fault saved in fault memory)
- . In all other cases: unit shut off, message on LCD (table 1 in machine status menu), unit fault LED lit steady, fault saved in fault memory, heat trace cabled turned on, fault relay in On position, boiler relay in On position if heating mode on and P111 = boiler.

•**Frost protection sensor for refrigerant in heat exchanger (1 or 2):** CTN 10 K at 25°C (if P2=1, 2 or 3 unless P1 = R407C, P2 = 3 and P3 = 2).

This sensor monitors the temperature of the refrigerant at the heat exchanger inlet in order to:

- Protect the heat exchanger from frost: - Refrigerant frost protection temperature displayed (display range: -40 to 99.9°C, resolution: 0.1 K)
- . Power reduced if several control stages are used - Automatic acknowledgement
- . Slope of fans changed
- . Unit shut off

E X C H . x R E F R . F R O S T  
P R O T . S E N S . F A U L T J x / x - x

- If the sensor wire is cut or the sensor short-circuits, the corresponding circuit is shut off, a message appears on the LCD, the circuit x fault LED is lit steady, the fault is saved in the fault

memory, the general fault relay is in the On position, and the auxiliary heaters are turned on if heating mode is on.

•**Coil sensor (A to D):** CTN 10 K at 25°C

If P2 = reversible air-to-water, this sensor manages the freon temperature at the coil outlet in order to:

- Manage (turn on and off) a defrosting cycle resolution: 0.1 K)
- Display the coil temperature (display range: -40 to 99.9°C, - Automatic acknowledgement

C O I L . x C I R C U I T x  
S E N S O R F A U L T J x / x - x

If the sensor wire is cut or the sensor short-circuits:

- In cooling mode:  
Normal operation, message on LCD, circuit x fault LED flashes, fault saved in fault memory.

- In heating mode:  
- If outdoor temperature ≥ 10°C → normal operation, message on LCD, circuit x fault LED flashes, fault saved in fault memory.
- If outdoor temperature < 10°C → circuit x shut off, message on LCD, circuit fault LED flashes, fault saved in fault memory.

•**Condenser hot water sensor:** CTN 10 K at 25°C (if P2 = 1 and P141 = 3 or 4) = P258 (if P2 = 1 and P141 = 1) = P257

This sensor monitors the water temperature at the condenser exchanger's inlet (or outlet) in order to:

- Adjust in heating mode 99.9°C, resolution: 0.1 K)
- Display the condenser's water temperature (display range: -40 to - Automatic acknowledgement

C O N D E N S E R I N L E T S E N S O R  
F A U L T J 7 / 5 - 6

- Sensor wire cut and short circuit:

- In cooling mode:  
Normal control, message on LCD, unit fault LED flashes, fault saved in fault memory, general fault relay in On position.
- In heating mode:  
Unit shut off, message on LCD, unit fault LED flashes, fault saved in fault memory, general fault relay in On position, boiler relay in On position if P111 = boiler.

• **Heat exchanger ambient sensor:** CTN 10 K at 25°C (if P2 = 2)

This sensor monitors the temperature inside the hydraulic enclosure housing the heat exchanger(s) in order to:

- Turn on the heaters
- Display the temperature inside the enclosure (display range: -40 to 99.9°C, resolution: 0.1 K)
- Automatic acknowledgement

E X C H A N G E R   A M B I E N T   T E M P .  
S E N S O R   F A U L T   J 7 / 5 - 6

- Sensor wire cut and short circuit: heaters turned on (relay in On position), message on LCD, unit fault LED flashes, fault saved in fault memory + general fault relay in On position.

• **Control stage discharge sensor (1, 2, 3 or 4):** CTN 50 K at 25°C (all configurations)

- Monitors the discharge temperature on the compressors
- Displays the discharge temperature (display range: 5 to 150°C, resolution 1 K).

D . T E M P .   S E N S O R   X   F A U L T  
J x / x - x

- If the sensor wire is cut (check 5 minutes after compressor turned on) and the sensor short-circuits (continuous monitoring), the corresponding control stage is turned off and the auxiliary heaters are turned on if need be. If there are no auxiliary heaters, the boiler relay moves to the On position if P111 = boiler. A message appears on the LCD, the circuit fault LED is lit steady, and the fault is saved in the fault memory.
- This fault must be acknowledged manually if the temperature < 145°C. The discharge fault must also be acknowledged.

• **Water manifold outlet sensor:** CTN 10 K at 25°C (if P2 = 1, 2 or 3 and P6 = 2)

This sensor monitors the water temperature on the exchanger outlet in order to:

- Adjust the unit (to water return)
- Display the common water outlet temperature (display range: -40 to 99.9°C, resolution: 0.1 K).
- Automatic acknowledgement

M A N I F .   W A T E R   O U T L E T  
S E N S O R   F A U L T   A D D 2   J 4 / 2 - 3

- Sensor wire cut and short circuit:
  - . If water return control or if P2 = water-to-water and heating mode on (i.e. sensor not used for control): Normal control, message from table 2 in machine status menu shown on LCD, unit fault LED flashes, fault saved in fault memory, general fault relay.
  - . If water outlet control and (cooling mode on or P2 = 3): Unit shut off, message from table 1 in machine status menu shown on LCD, unit fault LED lit steady, fault saved in fault memory, general fault relay

• **Circuit suction sensor:** CTN 10 K at 25°C (all configurations)

If P42 = 2 (electronic expansion valve on VCM board)

The sensor is connected to the expansion valve board and the temperature information is transmitted over the bus link.

The sensor monitors the suction temperature in order to:

- Display the superheat temperature (display range: -40 to 99.9°C, resolution: 0.1 K)
- Automatic acknowledgement
- If the sensor wire is cut or the sensor short-circuits:
  - . If P43 = No: a secondary fault is displayed, the fault LED flashes; the circuit fault relay is in the On position and the fault is automatically acknowledged
  - . If P43 = Yes: The corresponding circuit is turned off and the auxiliary heaters are turned on if need be. If there are no auxiliary heaters, the boiler relay moves to the On position. If P111 = Boiler. A message appears on the LCD, the circuit fault LED is lit steady, and the fault is saved in the fault memory and automatically acknowledged.

➤ Fault message:

S U C T I O N   T E M P .   S E N S O R  
F A U L T   C I R C U I . x   J x / x x - x x

• **Circuit liquid sensor:** CTN 10 K at 25°C (all configurations)

This sensor measures the liquid temperature in order to:

- Display the subcooling temperature (display range: -40 to 99.9°C, resolution: 0.1 K)
- Automatic acknowledgement
- If the sensor wire is cut or the sensor short-circuits, a secondary fault is displayed, the fault LED flashes, the circuit fault relay is in the On position, and the fault is automatically acknowledged

➤ Fault message:

L I Q U I D   T E M P .   S E N S O R  
F A U L T   C I R C . x   J x / x x - x x

• **Fault detection values:**

- For the 50 K sensors: Cut-off fault (or sensor absent) if < 5°C and the unit has been operating for 5 minutes, and sensor short-circuit if > 148 °C.
- For the 10 K sensors: Cut-off fault (or sensor absent) if < -40°C and sensor short-circuit if > 99°C.

•Correspondence table:

Temperature (°C)	SENSOR RESISTANCE Ω	
	DISCHARGE SENSOR 50 KΩ	CONTROL AND OUTDOOR SENSOR 10 KΩ
10	-	55340
-5	-	42340
0	162250	32660
5	126977	25400
10	99517	19900
15	78570	15710
20	62468	12490
25	50000	10000
30	40280	8058
35	32650	6532
40	26624	5326
45	21834	4368
50	18005	3602

10.2 Pressure sensor

The high and low values for the HP/LP pressure sensors are given below:  
 The sensors are adjusted using parameters P30 to P39.  
 Measurement range:

Low value from	High value to	
P31	P30	HP1
P33	P32	HP2
P37	P36	LP1
P39	P38	LP2

- Power supply: 5 V DC
- Signal: 0.5 - 4.5 V

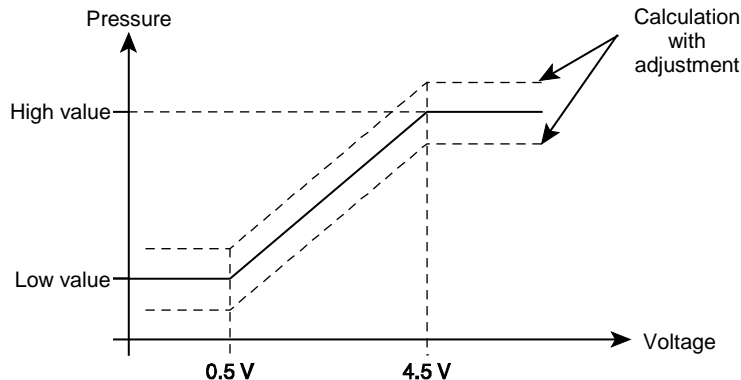

Short-circuit faults will be detected by a voltage  $\geq 4.75$  V.  
 This is not taken into account for the low-pressure sensors of each circuit when the unit has stopped or is in the defrosting phase.  
 For LP sensors, this fault is taken into account following a time

delay of 120 s from start-up.  
 Open-circuit faults will be detected by a voltage  $\leq 0.25$  V.  
 The pressure values given are for **relative pressure**.

•The HP sensor will:

- Monitor the HP pressure in the circuit and relay this information
- Control the unit using the HP

- Control the condensing pressure

•The LP sensor will:

- Monitor the LP pressure in the circuit and relay this information

- Monitor for refrigerant leaks before turning on stages

When reading the operation parameters for the pressure levels while the machine is on, the sensors can be adjusted with the **OK** button if there is a difference between a value that is read and the corresponding value measured by a pressure gauge.

Example:

```

P 3 x x H P x   P R E S S U R E   ↑
                x x . x b   ↓
    
```

Press **OK** to access and change the adjustment value.

```

S E N S O R   A D J U S T M E N T   H P x
                x x . x b           0 . 0 b
    
```

{ [- 1 + 2.5] 0 by default

Press **OK** to confirm the new adjustment value and go back to the operation parameter.  
 Press **ESC** to cancel any changes made and go back to the operation parameter.

This readjustment will be used to correct the difference between the value measured by a pressure sensor and the value read on a pressure gauge.  
 The resulting new slope will then be used for control.

11 MANAGEMENT OF THE WATER PUMPS

11.1 Pump 1

Pump 1 is assigned to the main hydraulic network. Therefore, it is used in all configurations:

- If P2 = air-to-water or reversible air-to-water and P25 = 2, it will be managed alternately with Pump 2.
- The pump that has run for the shortest amount of time starts up first.

11.2 Pump 2

Pump 2 is used only in certain configurations:

- A) If P2 = water-to-water, pump 2 is assigned to the customer's secondary network and its control mode is determined by P108.
- If P108 = depending on control mode, the pump control is linked to the unit control:



- Otherwise, the pumps may be turned on using the On/Off button (and automatic operation control input closed).
- The pump is shut off 1 minute after the last control stage turns off.

Pump x is turned on before the first control stage (where x is the value entered in P109).

The pump is shut off 1 minute after the last control stage turns off.

Automatic time delay countdown.

This time delay is maintained during test mode.

- If P108 = depending on On/Off, the pump control is linked to the operation of the unit.:
- . The pump is turned on (via On/Off and with the automatic operation control input closed; or via On/Off, with the automatic

- operation control input closed and winter protection activated by outdoor temperature; or remotely via a PC, modem or other).
- The pump is immediately turned off when P108 is changed and switches from On/Off control to Depending on control mode (unless control mode called for).
- The pump is shut off 1 minute after the last control stage turns off.

- B) If P2 = air-to-water or reversible air-to-water, it depends on P25
- If P25 = 0 or 1 (only one pump supplied.) there is no pump 2.
- If P25 = 2, the unit is supplied with a backup pump. This pump is managed by On/Off control and runs alternately with pump 1. The pump that has run for the shortest amount of time starts up first.

The next time the machine is turned off by the control after 7 days of operation with the same pump, the pumps are switched (by turning off the one that was running) in order to balance the runtimes.

The pump is shut off 1 minute after the last control stage turns off.

11.3 Pump management if P2 = 3 (reversible air-to-water) + heating mode + P111 = boiler

Parameter P27 is used to have the pump controlled by the operation of the boiler.

- A) If P27 = Yes: When the boiler is turned on, the pump is shut off unless there is a risk of the unit freezing (outdoor temperature ≤ P52 and P261 ≤ 30°C).

A tank with four nozzles must be installed on the system and the boiler must have its own pump and its own control with its own protections

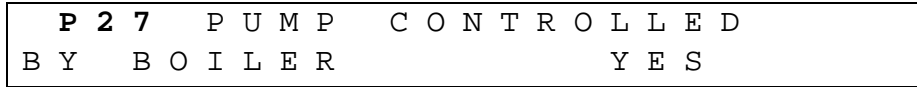

The boiler will continue to operate if the heat pump malfunctions.

- B) If P27 = No: The pump is controlled by the On/Off button. It continues to run even when the boiler is authorised to operate.

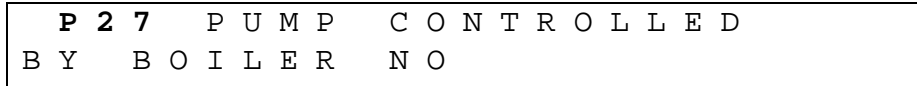

11.4 Unseizing the pumps

and switching

If any of the pumps remains off (for a reason other than a fault) for over 7 days, it must be turned on between 9.00 am and 9.00 pm and be allowed to run for 2 minutes.

- If P25 = 2, the pump with the longest runtime is turned off after being unseized.
- If the unit is turned off via the On/Off button or the automatic

operation control and a water flow fault occurs during unseizing, both pumps are turned off.

12 WINTER PROTECTION

12.1 Frost protection of pumps and heat exchangers while unit is off

This function protects the pump(s) and the heat exchanger(s) from freezing.

The heater and heat trace cable outputs are enabled only when P2 = air-to-water and reversible air-to-water.

P265 becomes visible if P2 = air-to-water and reversible air-to-water

12.1.1 Use with pure water: If P52 ≥ its standard adjustment value based on the refrigerant type:

- 1) Heater control:
- If exchanger ambient temperature ≤ P220 or ambient temp. sensor fault and water inlet temperature ≤ (P52 + 2) + all compressors off + pump off if P25 ≠ 0 → Heaters on.
  - If ambient temperature sensor fault and water inlet temperature ≤ (P52 + 2) + all compressors off + pump off if P25 ≠ 0 → Heaters on.
  - If exchanger ambient temperature > P220 + P222 or water inlet temperature ≥ (P52 + 2) + P222 or if a compressor or a pump is on if P25 ≠ 0 → Heaters off.

- 2) Heat trace cable control:
- If outdoor temperature sensor ≤ P220 and water inlet temperature ≤ 20°C + all compressors off + pump off if P25 ≠ 0 → Heat trace cables on
  - If outdoor temperature sensor fault and water inlet temperature ≤ 20°C + all compressors off + pump off if P25 ≠ 0 → Heat trace cables on
  - If outdoor temperature > P220 + P222 or water inlet temperature ≥ 20°C + P222 or if a compressor or a pump is on → Heat trace cables off.

**12.1.2 Use with glycol/water mix: If P52 < its standard adjustment value based on the refrigerant type:**

1) Heater control:

- If exchanger ambient temperature and water inlet temperature  $\leq P52 + 2 K$  + all compressors off + pump off if  $P25 \neq 0$  → Heaters on.
  - If exchanger ambient temp. sensor fault and water inlet temperature  $\leq P52 + 2 K$  + all compressors off + pump off if  $P25 \neq 0$  → Heaters on.
  - If exchanger ambient temperature  $P265$  or water inlet temperature  $> P52 + 2 + P222$  or if a compressor or a pump is on if  $P25 \neq 0$  → Heaters off.
- Output state displays:

<b>P 4 3 5</b> H E A T    T R A C E <span style="display: block; text-align: right;">O N</span>
<b>P 4 3 6</b> H E A T E R <span style="display: block; text-align: right;">O U T P U T                      O N</span>

2) Heat trace cable control:

- If outdoor temperature  $\leq 0$  and water inlet temperature  $\leq 0^\circ\text{C}$  + all compressors off + pump off if  $P25 \neq 0$  → Heaters on.
- If outdoor temperature sensor fault and water inlet temperature  $\leq 0^\circ\text{C}$  + all compressors off + pump off if  $P25 \neq 0$  → Heaters on.
- If outdoor temperature  $> 0 + P222$  or water inlet temperature  $\geq 0^\circ\text{C} + P222$  or if one compressor or a pump is on if  $P25 \neq 0$  → Heat trace cables off.

**12.1.3 Controlling frost protection for partial recovery (desuperheater) or total recovery option:**

<b>P 2 9 . 1</b> H E A T    R E C O V .    E X C H . <span style="display: block; text-align: right;">F R O S T    P R O T E C T I O N                      Y E S</span>
---

Parameter visible only if P2 (unit type) = air-to-water or reversible air-to-water:

- Default value:
- No if P29 (total recovery) = No
  - Yes if P29 = Yes
  - If P29.1 = Yes and outdoor temperature  $\leq P220$ : heat trace cables on
  - If P29.1 = Yes and outdoor temperature sensor fault: heat trace cables on
  - If P29.1 = Yes and outdoor temperature  $> P220 + P222$ : heat trace cables off.

The heat trace cables will be controlled by output 4 on terminal block J5 on additional board 1 (1-circuit cycle reversal). If P29.1 is set to 'Yes' and the link with additional board 1 is missing, a link fault should appear.

➤ Output state displays:

<b>P 4 3 7</b> R E C O V E R Y    F R O S T <span style="display: block; text-align: right;">P R O T .    O U T P U T                      O N</span>
--

**12.2 Water loop winter protection**

➤ In heating mode:

This function is possible only if P142 = Yes, the automatic operation control input is open and the On/Off button on the console is set to 'On'. In this case the function must maintain water inlet temperature on

the heat exchanger at  $30^\circ\text{C}$  as soon as the outdoor temperature falls below  $3^\circ\text{C}$  (2 K differential). The return temperature will be maintained at  $30^\circ\text{C}$  if the outdoor temperature sensor ever malfunctions.

➤ In cooling mode:

This function is possible only if P142 = Yes, the automatic operation control input is open and the On/Off button on the console is set to 'On'. In this case the pump is turned on if the

outdoor temperature falls below P220 and shut off at  $P220 + P222$ . The pump will be forced on if the outdoor temperature sensor ever malfunctions.

**13 MANAGEMENT OF THE FUNCTIONS**

**13.1 Management of the compressor protections**

**13.1.1 Short-cycle protection:**

Information from compressor manufacturer:  
 Compressors are not allowed to start more than 12 times an hour (on/off time of 5 minutes and minimum of 3 minutes between starts).  
 The on time + off time will be adjustable via parameter P50.

The auxiliary heaters do not operate during short-cycle protection. On power-up, the SCP = 0 minutes and the minimum off time = 3 minutes.

In test mode, the short-cycle protection is shunted. The compressor can start up immediately at the end of the pump start-up time delay.

S H O R T - C Y C L E    P R O T E C T I O N S T A G E x    C I R x    x x m n x x s
S T A G E x    C I R C U I T x    A T M I N .    S T O P                      x x m n x x s

The information is displayed only if a call is made to turn on the stage while the time delay is counting down.



### 13.1.2 Forced stop of compressors

This function prevents the compressor stages from operating individually. It is enabled and disabled via the following parameters:

P230: On authorisation, stage 1 circuit 1  
P231: On authorisation, stage 2 circuit 1

P232: On authorisation, stage 1 circuit 2  
P233: On authorisation, stage 2 circuit 2

### 13.2 Management of the time counters

The number of hours of operation in each mode (cooling and heating) can be viewed for each pump and each compressor stage.

The parameters are as follows:

P285: Heating mode runtime (in hours)  
P286: Cooling mode runtime (in hours)  
P287: Pump 1 runtime  
P288: Pump 2 runtime  
P311: Stage 1, circuit 1 runtime  
P314: Stage 2, circuit 1 runtime

P341: Stage 1, circuit 2 runtime  
P344: Stage 2, circuit 2 runtime

There are also monitoring counters: P289, P290, P308, P309, P310, P313, P322, P323, P324, P338, P339, P340, P343, P352, P353, and P354.

#### ➤ In heating mode (P285):

The time delay increments if heating mode is on via the On/Off button and the automatic operation control input is closed or the winter protection is on with a control stage on.

#### ➤ In defrost mode (P285):

These counters are visible if P285 is opened, Enter is pressed on the console and P159 = optimised.

The top line corresponds to the total runtime in heating mode (excluding defrosting). The second line corresponds to the total defrosting time. These counters have been added in order to know the gain compared to frosting during a fixed period of time.

#### ➤ In cooling mode (P286):

The time delay increments if cooling mode is on via the On/Off button and the automatic operation control input is closed or the winter protection is on with a control stage on.

### 13.3 Management of compressor start-up

Applies only for units with several compressors and if the number of stages on circuit 1  $\neq$  1 and the number of stages on circuit 2  $\neq$  1.

Parameter P13 is visible only:

- if P3 (No. of circuits) = 1 and P4 (No. of stages on circuit 1) = 2
- if P3 (No. of circuits) = 2 and P4 (No. of stages on circuit 1) = 2 and P5 (No. of stages on circuit 2) = 2

#### 13.3.1 With balanced tandem compressors:

Before stages are turned on, the runtime of each stage is always checked so that the stage that has run the least is started first.

When only one of the two compressors on each circuit is running, it is turned off after 4 hours and the other compressor is turned on.

##### ➤ With 1 circuit and 1 stage: No runtime balancing.

##### ➤ With 1 circuit and 2 stages: The two stages on the circuit are balanced (during operation and at start-up).

##### ➤ With 2 circuits and 3 stages: On circuit X, the first of the three stages to be turned on is the one that has run the least amount of time.

On circuit Y, the second stage to be turned on (circuit change) is the one that has run for the second-shortest time.

Then the third and last stage is started.

Then the fourth and last stage is turned on.

##### ➤ With 2 circuits and 4 stages: On circuit X, the first of the four stages to be turned on is the one that has run the least amount of time.

On circuit Y, the second stage to be turned on (circuit change) is the one that has run for the second-shortest time.

The third stage to be turned on is the stage that has run for the third-shortest time.

Then the fourth and last stage is turned on.

This function must take into account:

- The stage restriction
- The short-cycle protection
- The authorisation for the stages to turn on
- Compressor faults

The compressors are turned off in sequence, starting with the compressor that has run the longest.

#### 13.3.2 With unbalanced tandem compressors and partial-load control:

Partial-load control is enabled on water chillers equipped with scroll compressors with one or two refrigerating circuits with two or four control stages.

It makes it possible to manage up to six control stages using four compressor outputs.

On machines equipped with unbalanced tandem compressors, this type of control is particularly useful in obtaining the following breakdown:

If P3 (number of circuits) = 1 → 33%, 66%, 100%

If P3 = 2 → 16%, 33%, 50%, 66%, 83%, 100%

The stages must therefore be assigned on the compressor outputs

Motherboard

- Terminal 2 on terminal block J3, output of stage 1 on circuit 1 = most powerful stage on circuit 1

- Terminal 3 on terminal block J3, output of stage 2 on circuit 1 = most powerful stage on circuit 1

Additional board 2, circuit 2 function

- Terminal 2 on terminal block J3, output of stage 1 on circuit 2 = most powerful stage on circuit 2

- Terminal 3 on terminal block J3, output of stage 2 on circuit 2 = most powerful stage on circuit 2

##### ➤ With 1 circuit and 1 stage: No partial-load operation

##### ➤ With 2 circuits and 3 stages: No partial-load operation as the compressors are of the same size (LGN and LJA range). The compressor that has run the least is turned on first.

This function must take into account:

- The stage restriction,
- The short-cycle protection,
- The authorisation for the stages to turn on
- Compressor faults

##### ➤ Compressor switching management:

When only one of the two compressors on each circuit is running, it is turned off after 4 hours and the other compressor is turned on.

##### ➤ Short-cycle protection management (SCP):

- Call for power:

If the only available stage is in SCP mode, the machine remains in its current state and SCP is indicated by the flashing LED on the console. Before stages are turned on, the runtime of each stage is always checked so that the stage that has run the least is started first.

### 13.4 Compressor stopping sequence:

This stopping sequence allows you to delay the end of the second stage (the smallest compressor in the case of unbalanced tandem compressors) in relation to the end of the first stage in a dual staged start under the following three circumstances:

- On automatic operation control
- Following a defrosting request.
- After the defrosting "output" status

The end of the second stage will be delayed by P09 seconds in the three cases listed above.

**CLARIFICATION:** For machines with two circuits and two stages on each circuit operating at 100%.

If a stopping sequence is requested (on automatic operation control or before and after the defrosting phase with an intertwined coil): compressors 1 & 3 stop --> P09 seconds time delay --> compressors 2 & 4 stop.

### 13.5 Management of the reversing valves

The reversing valves are fitted on reversible units only.

They are managed by the following convention:

- In cooling mode: the reversing valves are supplied.
- In heating mode: the reversing valve are not supplied.

The supply to the reversing valves is cut off 30 minutes after the last stage on the corresponding circuit is turned off. This time delay becomes 30 seconds in test mode.

### 13.6 Management of configurable output P111:

The output between terminals 9-10 on terminal block J3 on the motherboard is configurable so that the customer can define its function.

**Max. power:** The NC contact informs the customer that the unit is running at full power (all compressors and all electric stages).

**Boiler:** The NC contact allows the customer to activate an auxiliary heater. This type of operating mode is described in section 21 "Management of the back-up boiler".

**Cooling/Heating:** The NC contact informs the customer of the heating operation of the unit. The NO contact informs the customer of the cooling operation of the unit.

Backup on all faults (on air-to-water machines only). The NC contact informs the customer that the machine is either not operating at full capacity (a compressor is off) or has been shut off following the detection of a fault. The machine will remain off until the fault is acknowledged with the Reset button.

Display:

M	A	C	H	I	N	E	O	F	F					
F	A	U	L	T	S	O	R	L	I	M	I	T	E	R

- Unit fault output active
- General fault LED on console lit steady

To see which type fault caused the machine to be shut off, go to the fault memory.

List of faults and impairments that shut off the machine if P111 is set to 'backup on all faults':

- |  |   |
|--|---|
| - Pump fault   | - Exchanger 1 or 2 water sensor fault                     |
| - Intermediate and final water flow fault            | - Refrigerant sensor fault                                |
| - Limiter on water outlet                            | - Discharge sensor fault                                  |
| - Intermediate and final water frost fault           | - Manifold water outlet sensor fault if control on outlet |
| - Limiter on refrigerant                             | - Sensor fault  |
| - Intermediate and final frost fault on refrigerant  | - Excessively low outdoor temperature fault               |
| - Exchanger frosting fault                           | - Electronic expansion valve fault                        |
| - Limiter on high pressure                           | - Fan fault if P3 and P180 = 1                            |
| - Intermediate and final high pressure control fault | - Maximum superheat fault                                 |
| - Manual high pressure fault                         | - Minimum superheat fault                                 |
| - Motor fault  | - Limiter on max. air during cooling                      |
| - Limiter on discharge                               | - Phase controller fault                                  |
| - Intermediate and final discharge fault             | - Suction sensor fault if P43 = Yes                       |
| - Intermediate and final low pressure fault          | - Excessively high outdoor temperature fault              |
| - Water inlet sensor fault                           |   |

## 14 SELF-ADJUSTING FUNCTIONS

These functions allow the machine to adjust itself to certain occasionally extreme operating conditions and thus avoid stops caused by faults.

### 14.1 Self-adjusting function: water frost limit

➤ Operation:

- Before shutting down after a fault occurs, the unit reduces its power by turning off a stage (if there are two on the circuit), or by reducing the compressor to half speed. In the case of INVERTER units, they shut off if they are already running at half speed.
- The threshold is detected by the water outlet sensor at P52 + 0.8 K.
- The unit returns to normal operation at P52 + 2 K for 5 minutes and then the HP gradually rises to its set threshold (P181).
- This function operates on each circuit.

➤ Display:

C	I	R	C	.	x	W	A	T	E	R	F	R	O	S	T	L	I	M
P	O	W	E	R	R	E	D	U	C	.								

**Special case for machines with two circuits and a single evaporator:**

- Before shutting down after a fault occurs, the unit reduces its power for minutes by turning off stages
- The threshold is detected by the water outlet sensor at P52 + 0.8
- Normal operation resumes when the water outlet temperature rises to a sufficient level by monitoring the temperature difference between the inlet and the outlet and the number of stages turned on.

### 14.2 Self-adjusting function: refrigerant frost limit

➤ Operation:

Before shutting down after a fault occurs, the unit reduces its power by turning off a stage (if there are two on the circuit), or by reducing the compressor to half speed. The threshold is detected by the sensor placed on the freon pipe at the evaporator inlet at P52 - P53 + 2 K for 10 seconds. The unit returns to normal operation at P52 - P53 + 3.5 K and then the HP gradually rises to its set threshold (P181).

➤ Display:

C I R C . x R E F R I G F R O S T  
P O W E R R E D U C .

**Exception: P08 = "SWEP DOUBLE":**

The limit is detected by the saturation temperature (LP side), at P52 – P53 for 60 seconds if at least one control stage is in operation. Normal operation resumes when the saturation temperature (LP side) rises to a sufficient level.

➤ Display:

C X E V A P T . / F R E E Z E L I M . X  
P O W E R R E D U C .

**14.3 Self-adjusting function: HP pressure limit**

➤ Operation:

- Before shutting down after a fault occurs, the unit reduces its power by turning off a stage, or by slowing the compressor to 50 Hz, or by shutting off Inverter units for 30 minutes.

- The threshold is detected by the HP sensor at P54-P195 and returned to normal operation after 30 minutes.

- This time period becomes 30 seconds in test mode.

This function is turned on on both circuits at the same time.

➤ Display:

C I R C U I T x H P L I M I T  
P W R R E D U C T I O N x x m n

**Special case of Inverter machines in water heating mode:**

If the HP pressure  $\geq$  P54 - P195, the controller **adjusts the control setpoint** so as not to push the compressors near their limits too often. If necessary, a coil defrosting cycle will be forced on.

**Special case for water-to-water machines in water heating mode:**

Normal operation of the machine turning on the compressor stages resumes if the high pressure and the water inlet temperature have dropped sufficiently in relation to the point at which load shedding was activated.

**Special case for water-to-water machines in master-slave mode:**

The machine is in Fault mode for the first HP cut-off when a single compressor stage is in operation so that the slave machine can start up from the first HP cut-off in the master machine.

**14.4 Self-adjusting function: discharge protection, circuit 1 or 2**

➤ Operation:

- Before shutting down after a circuit fault occurs, the unit reduces its power for 30 minutes by turning off a stage.

- The threshold is detected by the discharge sensor at value P51 and the stage that was turned off is returned to normal operation after 30 minutes.

- This time period becomes 30 seconds in test mode.

➤ Display:

C I R C . X D . T E M P L I M I T  
P W R R E D U C T I O N x x m n

**Special case for machines in water heating mode:**

reversible

If the discharge circuit temperature  $\geq$  P151, the controller **adjusts the control setpoint** so as not to push the compressors near their limits too often.

If necessary, a coil defrosting cycle will be forced on.

**14.5 Self-adjusting function: minimum HP, circuit 1 or 2**

➤ Operation:

- If the pressure measured by the HP sensor is  $\leq$  P63 for water-to-water units, the controller lowers the circuit's power to avoid an excessive drop in LP. Normal operation is restored at P63 + 1b.

➤ Display:

C I R C . x M I N . H P L I M .  
P O W E R R E D U C .

**14.6 Self-adjusting function for high water return temperatures**

➤ Operation:

- The water return temperature may be high as the installation warms up in cooling mode. This causes all the compressor stages to turn on one after the other and can result in HP cuts and unwanted voltage spikes.

- To prevent this, the controller limits the turning-on of the stages if the water inlet temperature on the heat exchanger is higher than P171 as long as the temperature does not drop below P171-5K.

➤ Display:

W A T E R R E T U R N T . L I M I T  
U N I T P W R R E D U C T I O N

**15 FAULT FUNCTIONS**

**15.1 Water frost limit fault on circuits 1 and 2**

➤ Operation:

- Should the self-adjusting function be insufficient, a fault will occur on the unit when the temperature measured on the heat exchanger water outlet is at P52 (measured for 15 seconds, or P52 – 1 K).

**If this fault causes fewer than 3 shutdowns in 24 hours:**

- Corresponding circuit shut off.

- Circuit fault output off

- Frost protection fault relay on optional board in Off position

- Circuit fault LED on console **flashes**

➤ Display:

```
C I R C X H 2 O F R O S T F A U L T
X C U T ( S ) I N 2 4 H
```

**If this fault causes more than 3 shutdowns in 24 hours:**

- Corresponding circuit shut off.
- Fault output on
- Frost protection fault relay on optional board in On position
- Circuit fault LED on console lit **steady**
- Boiler on if P111 = Boiler and heating mode.
- Auxiliary heaters on if P22 = Yes and heating mode.

➤ Display:

```
C I R C U I T X O F F
W A T E R F R O S T F A U L T
```

➤ Saved in fault memory:

```
x . W A T E R x F R O S T P R O T .
```

➤ Resetting:

- If the number of faults in 24 hours  $\leq 3$  → the fault is automatically acknowledged if the temperature rises back above P52 + 6 K.
- If the number of faults in 24 hours  $> 3$  → the fault is acknowledged if the temperature rises back above P52 + 6 K and **Reset** is pressed on the console.

### 15.2 Refrigerant frost limit fault on circuits 1 and 2

Frost on the heat exchangers is detected in two ways on most machines.

- Detection method 1: sensors monitor for deviations in low pressure and in the water outlet temperature. Such deviations indicate that ice has started to form on the heat exchanger. There is no self-adjusting function; the risk of freezing is immediately handled as a fault.
- Parameters P58 and P59 are used in this mode of detection. Therefore, the lower their values, the more the frost protection is sensitive.

➤ Display:

```
C I R C U I T X O F F
E X C H . A N T I F R E Z E F A U L T
```

This function can be turned off via parameter P115 in order to perform maintenance.

- Detection method 2: frost is detected by a freon sensor on the heat exchanger inlet:

```
C I R C X R E F F R O S T F A U L T
X C U T ( S ) I N 2 4 H
```

➤ Operation:

- Should the self-adjusting function be insufficient, a fault will occur on the unit when the temperature measured on the freon pipe at the heat exchanger inlet or the saturation temperature is at P52 - P53 (measured for 60 seconds).

**If this fault causes fewer than 3 shutdowns in 24 hours**

- Corresponding circuit shut off.
- Circuit fault output off
- Frost protection fault relay on optional board in Off position
- Circuit fault LED on console **flashes**

➤ Display:

```
C I R C X R E F F R O S T F A U L T
X C U T ( S ) I N 2 4 H
```

**If this fault causes more than 3 shutdowns in 24 hours:**

- Corresponding circuit shut off.
- Fault output on
- Frost protection fault relay on optional board in On position
- Circuit fault LED on console lit **steady**
- Boiler on if P111 = Boiler and heating mode.
- Auxiliary heaters if P22 = Yes + heating mode

➤ Display:

```
C I R C U I T X O F F
R E F R I G . F R O S T F A U L T
```

➤ Saved in fault memory:

```
x . R E F R I G . x F R O S T P R O T
```

➤ Resetting:

- If the number of faults in 24 hours  $\leq 3$  → the fault is automatically acknowledged if the temperature rises back above P52 - P53 +10 K.
- If the number of faults in 24 hours  $> 3$  → the fault is acknowledged if the temperature rises back above P52 - P53 +10 K and **Reset** is pressed on the console.

### 15.3 HP pressure fault, circuits 1 and 2

➤ Operation:

- Information is sent by the pressure sensors on each circuit. This function prevents manual HP cuts during brief increases in HP during momentary blockages in the condenser.
- Should the self-adjusting function be insufficient, a fault will occur on the circuit when the pressure measured is at P54.

**If this fault causes fewer than 5 shutdowns in 24 hours:**

- Corresponding circuit shut off.
- 30 min. time delay (in seconds in test mode).
- Fault output off
- Circuit x HP fault relay on optional board in Off position
- Circuit fault LED on console **flashes**.
- The number of faults over a 24 hour period is managed (P308 for circuit 1 and P338 for circuit 2).

➤ Display:

```
C I R x   H P   F A U L T   x x m n
X   C U T ( S )   I N   2 4 H
```

**If this fault causes more than 5 shutdowns in 24 hours:**

- Corresponding circuit shut off.
- Fault output off.

- Circuit x HP fault relay on optional board in On position.
- Circuit LED on console lit **steady**.

➤ Display:

```
C I R C U I T   X   O F F
H P   F A U L T
```

➤ Saved in fault memory:

```
x . C I R C U I T x   H P
```

➤ Resetting:

- If the number of faults in 24 hours  $\leq 5$  → the fault is acknowledged after 30 minutes.
- If the number of faults in 24 hours  $> 5$  → the fault is acknowledged if **Reset** is pressed on the console

### 15.4 Discharge temperature fault, circuit 1 or 2

➤ Operation:

- Information is sent by the sensors placed on the discharge pipes (one per control stage).
- The maximum discharge temperature limit is set by parameter P51 + 1 K in air conditioning and P51 for 1 minute in heat pump

**If this fault causes fewer than 5 shutdowns in 24 hours:**

- Corresponding circuit shut off.
- 30 min. time delay (in seconds in test mode)
- Fault output off

- Circuit x discharge temperature fault relay on optional board in Off position
- Circuit fault LED on console **flashes**.

➤ Display:

```
D . T E M P   F A U L T   C x   x x m n
X   C U T ( S )   I N   2 4 H
```

**If this fault causes more than 5 shutdowns in 24 hours:**

- Corresponding circuit shut off.
- Fault output on
- Circuit x discharge temperature fault relay on optional board in

- On position
- Circuit fault LED on console lit **steady**

➤ Display:

```
C I R C U I T   X   O F F
D I S C H A R G E   F A U L T
```

➤ Saved in fault memory:

```
x - D I S C H . T .   C I R C U I T x
```

➤ Resetting:

- If the number of faults in 24 hours  $\leq 5$  → the fault is acknowledged after 30 minutes.
- If the number of faults in 24 hours  $> 5$  → the fault is acknowledged if DISCH.T.  $\leq P51 - 15^{\circ}\text{C}$  and **Reset** is pressed on the console.

### 15.5 LP fault on circuit 1 or 2

➤ Operation:

- If the pressure measured by the LP pressure sensor is  $\leq P55$ , the controller records an LP fault.
- This input is checked 2 minutes after the first stage on the circuit is turned on. It is also checked when power is shut off but ignored both during and 2 minutes after defrosting.
- Both of these time delays are maintained in test mode.

**If this fault causes fewer than 3 shutdowns in 24 hours:**

- Corresponding circuit shut off.
- Fault output off

- Circuit x LP fault relay on optional board in Off position
- Circuit fault LED on console **flashes**

➤ Display:

```
C I R C U I T   x   L P   F A U L T
X   C U T ( S )   I N   2 4 H
```

**If this fault causes more than 3 shutdowns in 24 hours:**

- Corresponding circuit shut off.
- Fault output on

- Circuit x LP fault relay on optional board in On position
- Circuit fault LED on console lit **steady**

➤ Display:

```
C I R C U I T   X   O F F
L P   F A U L T
```

➤ Saved in fault memory:

X . C I R C U I T X L P

➤ Resetting:

- If the number of faults in 24 hours  $\leq 3$  → the fault is automatically acknowledged if BP > P55 + 2b.
- If the number of faults in 24 hours > 3 → the fault is acknowledged if BP > P55 + 2b and **Reset** is pressed on the console.

If a fault occurs on the sensor on the open circuit, the fault is preceded in the fault memory by an LP fault.

**Special case for reversible machines and water chilling:**

the fault threshold switches to P55+1 b and normal operation is restored if BP > P55 + 3 b.

**Special case for reversible machines and water heating:**

Defrosting is forced on when the LP is < P55 for 1 minute.

If defrosting is forced on 3 times in 1 hour, the circuit with a LP fault is turned off the fourth time the LP drops below P55.

### 15.6 Management of superheat faults

The superheat temperature on the suction end of each circuit can be monitored by comparing the LP saturation temperature to the suction temperature.

This protection is enabled by setting P43 to 'Yes' (No by default). It protects the compressor(s) from excessively low or high superheat values.

If superheat protection = Yes → This function is turned on when at least the first control stage (per circuit) is on and 5 minutes after the first stage is turned on.

**Minimum superheat fault:**

- If the superheat value (P307 or P337) drops below the minimum superheat limit value (P44) for 1 minute, the circuit is shut off and the minimum superheat error message is displayed.
- The unit automatically restarts after 5 minutes (5 seconds in test mode).
- This function remains on in test mode.

➤ Display:

M I N S U P E R H E A T F A U L T C X  
X C U T ( S ) I N 1 H

If there are more than 3 cuts in 1 hour

The unit is turned off by the superheat protection. The **Reset** button must be pressed in order to restart the circuit.

➤ Display:

C I R C U I T X O F F  
M I N . S U P E R H E A T F A U L T

**Maximum superheat fault:**

- If the superheat value (P307 or P337) rises above the maximum superheat limit value (P45) for 1 minute and the evaporating temperature < 15°C, the circuit is shut off and the maximum superheat error message is displayed.
- This function is turned off during defrosting.
- The unit automatically restarts after 5 minutes (5 seconds in test mode).
- This function remains on in test mode.

➤ Display:

M A X S U P E R H E A T F A U L T C X  
X C U T ( S ) I N 1 H

If there are more than 3 cuts in 1 hour, the unit is turned off by the maximum superheat protection and the **Reset** button must be pressed in order to restart the circuit.

➤ Display:

C I R C U I T X O F F  
M A X . S U P E R H E A T F A U L T

➤ If a permanent fault occurs:

- Fault stored in memory in case of a mains power failure
- Fault saved in fault memory
- Relay in On position

➤ If a temporary fault occurs:

- Fault not stored in memory if a mains power failure occurs
- Fault saved in fault memory
- The minimum or maximum superheat fault relay on the relay board is in the Off position
- During test mode, the time delays are counted down in seconds, not minutes.

➤ Messages in the fault memory:

C X M I N . O V E R H E A T

C X M A X . O V E R H E A T

## 16 CONTROLS

### 16.1 Main control in cooling and heating modes

#### Definition and principle:

The chilled water and hot water temperatures are measured and compared with the setpoint value. Depending on the result, the compressor stages are turned on or off. This check is performed on the heat exchanger's water outlet (water supply = PIDr) or water inlet (water return).

#### 16.1.1 Operating mode selection (P119):

- If P119 = 1 (Cooling)

Cooling only.

- If P119 = 2 (Heating)

Heating only

- If P119 = 3 (Cooling/Heating via console)

The operating mode can be changed only with the machine stopped (automatic operation control input set to on, On/Off button).

The Heating/Cooling button will be disabled if it is pressed while the machine is running.

- If P119 = 4 (Cooling/Heating via on/off input)

The operating mode can be changed only with the machine stopped (automatic operation control input set to on, On/Off button).

Attempting to change the operating mode while the machine is running will result in a fault:

. Machine stopped.

. General fault LED on.

. Machine fault relay in On position.

. Initial operating mode LED flashes

M	A	C	H	I	N	E		O	F	F										
O	P	E	R	A	T	I	N	G		M	O	D	E		C	H	A	N	G	E

#### Automatic reset:

- Either the machine changes its operating mode if the change is confirmed by pressing On/Off or if the automatic operation control input is open;

- Or it resumes its initial operating mode if the input is restored to its initial value.

#### If P119 = 5, the machine switches between heating and cooling depending on the outdoor temperature:

- This function is visible only if P2 = reversible air-to-water

- When this function is turned on, the minimum heating limit and the maximum cooling limit (depending on the outdoor temperature) are re-enabled and are set to the following values:

. For a minimum air temperature of -10°C if P7 ≠ INVERTER

-20°C if P7 = INVERTER

. For a maximum air temperature of 46°C.

However, they can be disabled.

P	1	3	6		M	A	X		A	I	R		T	E	M	P	.			
A	U	T	O		H	E	A	T	I	N	G		M	O	D	E		-	x	x

P	1	3	7		M	I	N		A	I	R		T	E	M	P	.			
A	U	T	O		C	O	O	L	I	N	G		M	O	D	E		-	x	x

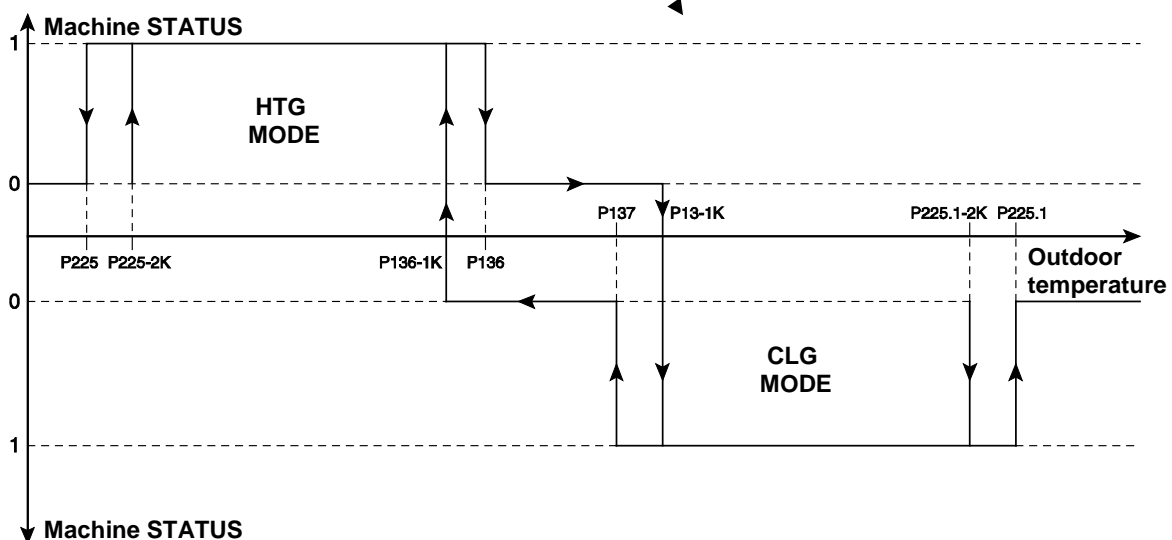

- When an operating mode reaches its end temperature setpoint in automatic mode, the following message is displayed until a mode is turned on:

D	E	A	D		B	A	N	D		A	U	T	O								
					H	E	A	T	I	N	G		/		C	O	O	L	I	N	G

The two heating and cooling LEDs flash while this message is displayed. The pump is shut off in the deadband.

## 16.2 Water temperature setpoint adjustment

The control mode is set using parameter P141.

Value 1: set to water return.

Value 2: set to water supply.

Value 3: set to water supply with compensation by water return.

Setpoint 2 allows a similar shift if control adjusted based on the outdoor air (If P127 = Yes or P131 = Yes) or allows the control mode to be changed if P54 (storage) = Yes.

## 16.3 Adjustment of water temperature setpoint if P7 ≠ INVERTER

### 16.3.1 Water return control (P141 = 1):

The temperature used to adjust the setpoint is measured by:

- the inlet sensor on heat exchanger 1 if P2 = air-to-water or reversible air-to-water, if P2 = water-to-water and cooling mode,
- the hot water sensor if P2 = water-to-water and heating mode.

The difference between the control temperature the setpoint is compared to the stage differential and the interstage differential. Depending on the result, it will be necessary to either turn on an additional stage or to turn one off.

Each stage is turned on at 60-second intervals and the shut off at 1-second intervals.

#### The related parameters are as follows:

P143: Stage differential

P251: Control setpoint

P144: Interstage differential

➤ In cooling mode:

- A call is made for an additional stage if  $T > \text{Setpoint} + \text{SD} + (\text{ISD} \times \text{NSO})$

- A call is made to stop a stage if  $T < \text{Setpoint} + (\text{ISD} \times \text{NSO} - 1)$

Where:

T: Control temperature (measured).

ISD: Interstage Differential (P144)

STP: Setpoint

NSO: Number of Stages On

SD: Stage Differential (P143)

Example: Two-stage water chiller

Parameter settings: STP = 10°C, SD = 2 K, ISD = 1.5 K

Stage 1		Stage 2	
On	Off	On	Off
12	10	13.5	11.5

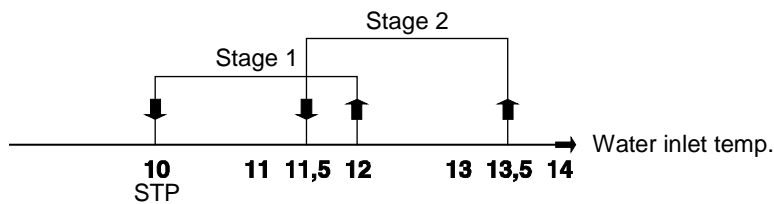

➤ In heating mode:

- A call is made for an additional stage if  $T < \text{STP} - \text{SD} - (\text{ISD} \times \text{NSO})$

- A call is made to stop a stage if  $T > \text{STP} - (\text{ISD} \times \text{NSO} - 1)$

Where:

T: Control temperature (measured).

ISD: Interstage Differential (P144)

STP: Setpoint

NSO: Number of Stages On

SD: Stage Differential (P143)

Example: Two-stage water heater for a water temperature range of 35-40°C.

Parameter settings: STP = 40°C, SD = 2 K, ISD = 1.5 K.

Stage 1		Stage 2	
On	Off	On	Off
38	40	36.5	38.5

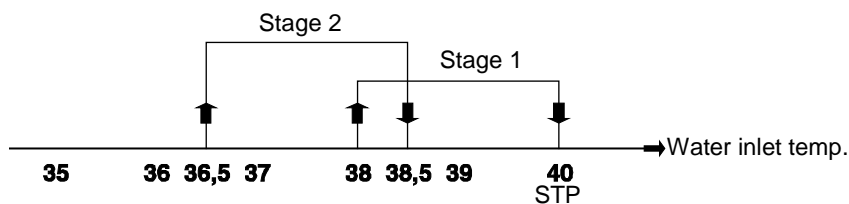

R	E	T	U	R	N	T	E	M	P	.	:	-	x	x	.	x	°
S	E	T	P	O	I	N	T	:	:	-	x	x	.	x	°		



**16.3.2 Water supply control (P141 = 2)**

If heating mode is selected with a water-to-water unit, the setpoint is adjusted based on the temperature measured by the hot water supply sensor. If cooling mode is selected and P6 = 1, the setpoint is adjusted based on the temperature measured by the heat exchanger outlet sensor. If P6 = 2 in the same mode, it is adjusted based on the temperature measured by the manifold sensor. The type of control used is PIDr.

The temperature is measured periodically (τ) then compared to the setpoint and multiplied by a proportional coefficient (P) -- taking into account the difference between the measurement and the setpoint (D) and the change in the difference between the measurement and the setpoint (I) -- in order to approach the setpoint quickly.

Formula:  $EC = P (M-C) t1 + S (M-C)*I + [(M-C) t0 - (M-C) t1]*D$

M = Measurement, S = Setpoint.

When P146 = 0 and P147 = 0 (standard setting), the PIDr function becomes PT (the Integral and Derivative functions are disabled)

**The related parameters are as follows:**

- P251: Calculated setpoint
- P121: Setpoint 1 in cooling mode
- P123: Setpoint 1 in heating mode
- P145: P coefficient
- P146: I coefficient
- P147: D coefficient
- P148: T coefficient

➤ In cooling mode:

A call is made for an additional stage if:  
DV > +1.0 K for the first stage and +0.5 K for the additional stages.

A call is made to turn off a stage if:  
DV < -0.5 K for a stage and -1.0 K for the last stage.

Example: Two-stage unit with a 5°C setpoint, where D = 0 and I = 0.

P	Stage 1		Stage 2		Stage 1
	Off		On		
0.5	3	4	6	7	
1	4	4.5	5.5	6	
1.5	4.33	4.66	5.33	5.66	
2	4.5	4.75	5.25	5.5	

➤ In heating mode:

A call is made for an additional stage if:  
DV < -1.0 K for the first stage and -0.5 K for the additional stages.

A call is made to turn off a stage if:  
DV > +0.5 K for a stage and +1.0 K for the last stage.

Example: Two-stage unit with a 45°C setpoint. I = 0 and D = 0.

P	Stage 1		Stage 2		Stage 1
	On		Off		
0.5	43	44	46	47	
1	44	44.5	45.5	46	
1.5	44.34	44.66	45.33	45.66	
2	44.5	44.75	45.25	45.9	

S U P P L Y    T E M P . : - x x . x °
S E T P O I N T                : - x x . x °

**16.3.3 Adjusting the setpoint to the water supply with compensation on the water return (P141 = 3):**

➤ Aim:

Allow the control system to anticipate changes in load on the loop by monitoring for variations in the water inlet temperature.

➤ Action:

Adjusts the controller time delay.

➤ Principle:

The water return temperature is measured: θt0; evaporator in cooling mode, condenser in heating mode at time t0 then t0 + P151. The calculated temperature variation [θt1 - θt0] is used to define the compensator coefficient.

The PID control polling time then becomes: remaining time x compensator coefficient.

Configuring the compensator coefficient: The compensator coefficient can be set to between 0.1 and 1. (Parameter P150)

- If the compensator coefficient = 1 → the function is disabled.
- If the water return temperature variation < 0.5°C → no compensation.

The compensator coefficient is maximum when the temperature variation = 10°C between each time α.

➤ Compensator coefficient diagram:

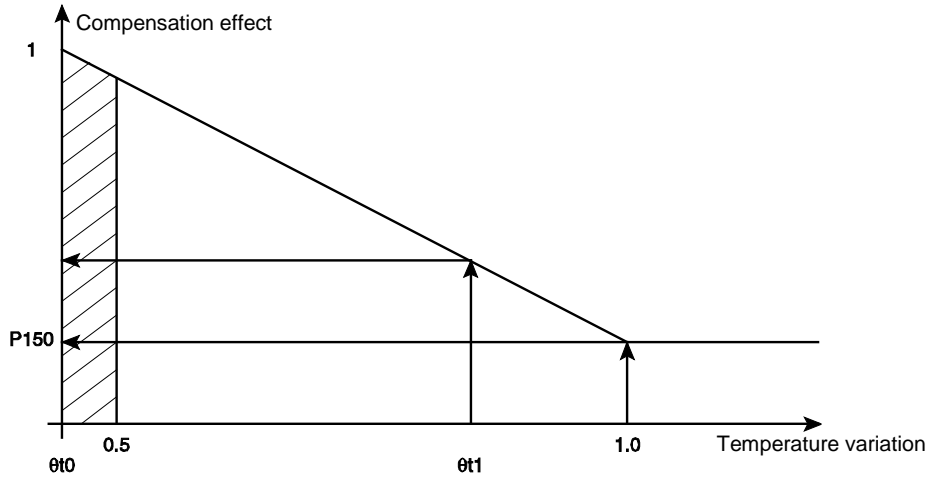

Example with a compensation factor of 0.5  
 Controller time delay P148 = 100 seconds  
 Compensation time P151 = 10 seconds

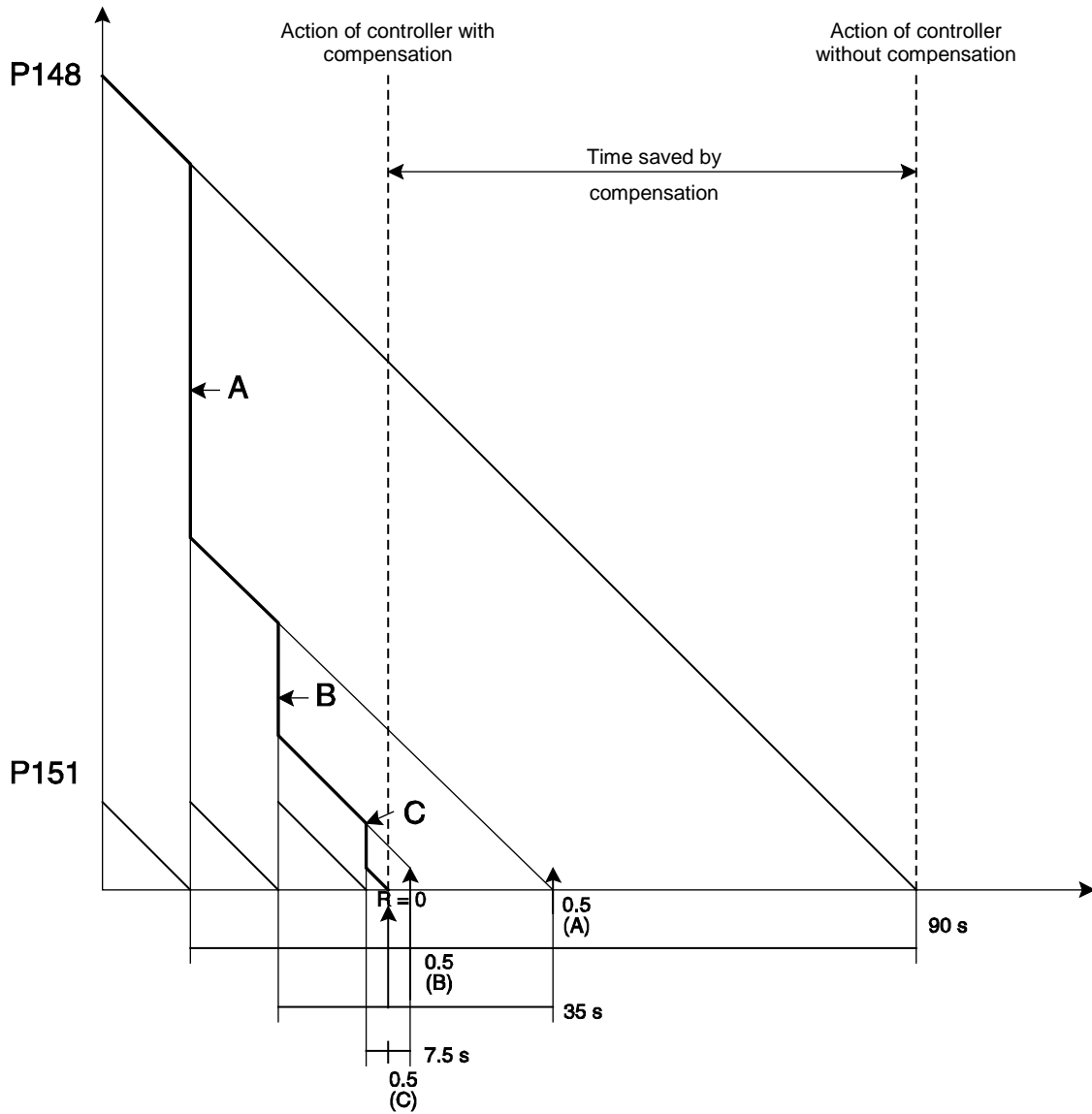

**A:** 1<sup>st</sup> compensation result. The controller's remaining time is  $(100 - 10 = 90 \text{ seconds}) \times 0.5 = 45 \text{ seconds}$ .  
**B:** 2<sup>nd</sup> compensation result. The controller's remaining time is  $(45 - 10 = 35 \text{ seconds}) \times 0.5 = 17.5 \text{ seconds}$

**C:** 3<sup>rd</sup> compensation result. The controller's remaining time is  $(17.5 - 10 = 7.5 \text{ seconds}) \times 0.5 = 3.75 \text{ seconds}$ .  
**R = 0:** Moment when the controller's time delay = 0.  
 The two time delays are resynchronised at this moment.

**The related parameters are as follows:**

P145: P coefficient  
 P146: I coefficient  
 P147: D coefficient

P148: T coefficient (polling time)  
 P150: Minimum compensation setpoint  
 P151: Compensation time

S U P P L Y	T E M P .	:	-	x	x	.	x	°
S E T P O I N T		:	-	x	x	.	x	°

**16.4 Adjustment of setpoint for the water supply and return temperatures (P141 = 1 or 2) if P7 = INVERTER**

The difference between the control temperature the setpoint is compared to the stage differential and the interstage differential. Depending on the result, it will be necessary to either turn on the compressor and increase its speed or to decrease its speed and turn it off.

- In cooling mode
  - A call will be made to turn on the compressor if:  $T > STP + \text{Stage differential}$
  - The compressor rotation speed will be progressively increased if  $(STP + \text{Stage differential}) < T < (STP + \text{Stage differential} + \text{Interstage differential})$

Conversely, the compressor speed will be progressively decreased as the water return temperature approaches the setpoint value.

- The compressor will be shut off when  $T < STP$

- In heating mode
  - A call will be made to turn on the compressor if  $T < STP + \text{Stage differential}$
  - The compressor rotation speed will be progressively increased if  $(STP - \text{Stage differential} - \text{Interstage differential}) < T < (STP - \text{Stage differential})$
  - The compressor will be shut off as soon as  $T > STP$

Conversely, the compressor speed will be progressively decreased as the water return temperature approaches the setpoint value. The temperature used to adjust the setpoint is measured by the sensor on the water outlet or inlet of the heat exchanger based on the value of P141.

➤ In cooling mode:

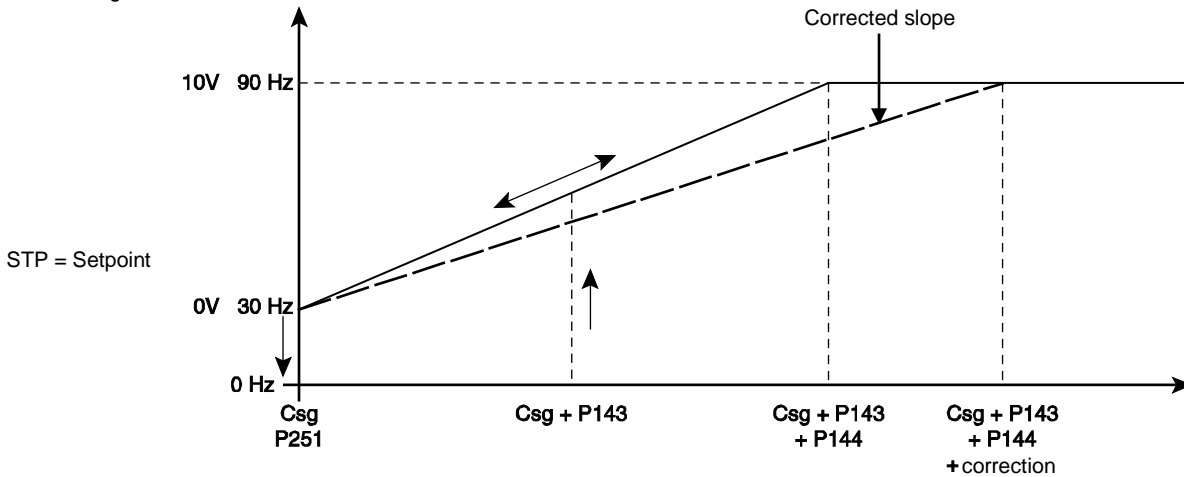

➤ In heating mode:

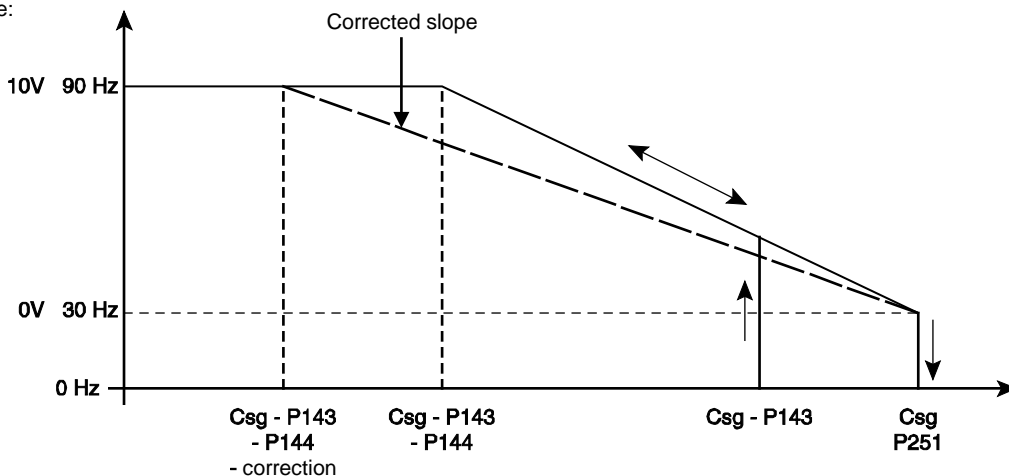

Csg = STP > Correction management:

Correction is enabled if P7 = Inverter and if P141 = supply and return.

The correction factor is used to prevent the compressor from running during short-cycle protection and too-short runtimes caused by a lack of inertia in the system.

The correction factor On/Off button is set to '0' at power-up.

## 16.5 Storage control

If P154 = No → The control mode remains standard and may be adjusted to the return or supply line depending on the value of P141 (control mode).

If P154 = Yes → Storage control is enabled. The control mode is managed based on the setpoint selected:

This type of control makes it possible to generate maximum capacity at a given time, often when electricity is cheapest.

- One after the other, the compressor stages turn on in 10-second intervals at value P122 + P155. When P122 is reached, the stages are shut off at the rate of one per second.
- The setpoint 2 LED lights up.
- All limits are maintained.

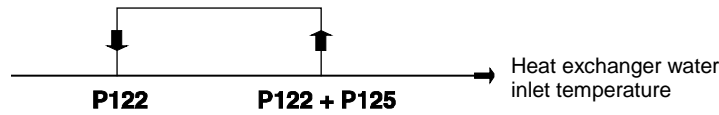

**NOTE:** Control based on the outdoor temperature is not available if setpoint 2 is selected. It is, however, available with setpoint 1. This operating mode is available in cooling mode only.

R	E	T	U	R	N	T	E	M	P	.	:	-	x	x	.	x	°
S	E	T	P	O	I	N	T	.	:	-	x	x	.	x	°		

## 16.6 Control setpoint (P251) management

### 16.6.1 If P142 (water loop winter protection) = No:

#### • If P120 (setpoint No.) = 1

➤ In cooling mode:

If P127 cooling setpoint adjustment = f (outdoor temperature) = 0 or outdoor sensor fault; Control setpoint = P121

If P127 = 1 and no fault on outdoor sensor, setpoint f (outdoor temperature) is calculated using P121.

➤ In heating mode:

If P131 heating setpoint adjustment = f (outdoor temperature) = 0 or outdoor sensor fault; Control setpoint = P123

If P131 = 1 and no fault on outdoor sensor, setpoint f (outdoor temperature) is calculated using P123.

#### • If P120 (setpoint No.) = 2 selected via console

➤ In cooling mode:

If P127 cooling setpoint adjustment = f (outdoor temperature) = 0 or outdoor sensor fault; Control setpoint = P121 or P122 depending on selection on console

If P127 = 1 and no fault on outdoor sensor; Setpoint f (outdoor temperature) is calculated using P121 or P122 based on the selection made via the console.

➤ In heating mode:

If P131 heating setpoint adjustment = f (outdoor temperature) = 0 or outdoor sensor fault; Control setpoint = P123 or P124 depending on selection on console

If P131 = 1 and no fault on outdoor sensor; Setpoint f (outdoor temperature) is calculated using P123 or P124 based on the selection made via the console.

#### • If P120 (setpoint No.) = 2 selected via on/off input

The on/off input corresponds to terminals 4-5 on terminal block J6 on the motherboard.

➤ In cooling mode:

If P127 cooling setpoint adjustment = f (outdoor temperature) = 0 or outdoor sensor fault; Control setpoint = P121 if on/off input open; P122 if on/off input closed.

If P127 = 1 and no fault on outdoor sensor:

- Setpoint f (outdoor temperature) is calculated using P121 if the on/off input is open.
- Setpoint f (outdoor temperature) is calculated using P122 if the on/off input is closed.

➤ In heating mode:

If P131 = 0 or outdoor sensor fault; control setpoint = P123 if on/off input open; P124 if on/off input closed.

If P131 heating setpoint adjustment = f (outdoor temperature) = 1 and no fault on outdoor sensor:

- Setpoint f (outdoor temperature) is calculated using P123 if the on/off input is open.
- Setpoint f (outdoor temperature) is calculated using P124 if the on/off input is closed.

### 16.6.2 If P142 (water loop winter protection) = Yes and automatic operation control input open:

The control setpoint = 30°C.

### 16.6.3. Management of the setpoint based on the outdoor temperature:

The water controls in COOLING and heating mode are activated by default (P127 and P131 are set to “Yes” by default).

Gradients are managed during operation with two setpoints in the following manner:

Depending on the outdoor temperature, the water control with setpoint 2 is parallel to the control set using setpoint 1. The shift is equal to the difference between the two setpoints (setpoint 1 – setpoint 2), see the graphs below.

**NOTE:** Minimum setting of 5 K between start and end of setpoint drift.

➤ Slope adjustment in cooling mode  
The related parameters are as follows:

- P121: Cooling setpoint 1
- P122: Cooling setpoint 2
- P251 Corrected setpoint

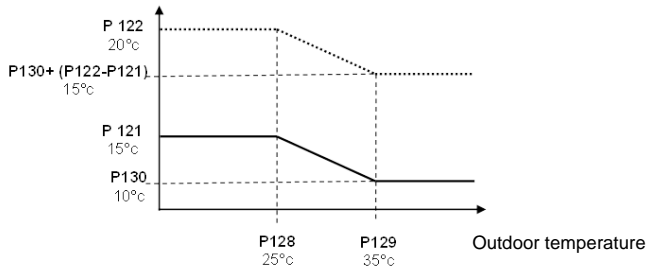

- P128: Outdoor temperature at start of drift in cooling mode
- P129: Outdoor temperature at end of drift in cooling mode
- P130: Maximum setpoint at end of drift in cooling mode
- P251 Corrected setpoint

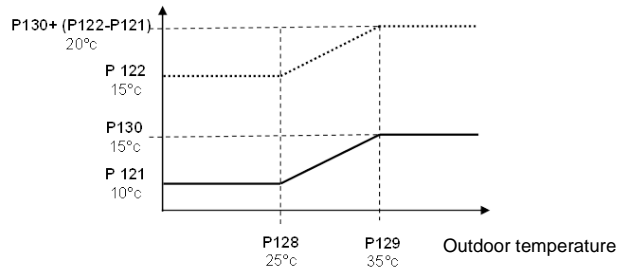

➤ Slope adjustment in heating mode

- The related parameters are as follows:
- P123: heating setpoint 1
- P124: heating setpoint 2

- P132: Outdoor temperature at start of drift in heating mode
- P133: Outdoor temperature at end of drift in heating mode
- P134: Maximum setpoint at end of drift in heating mode

P251 Corrected setpoint

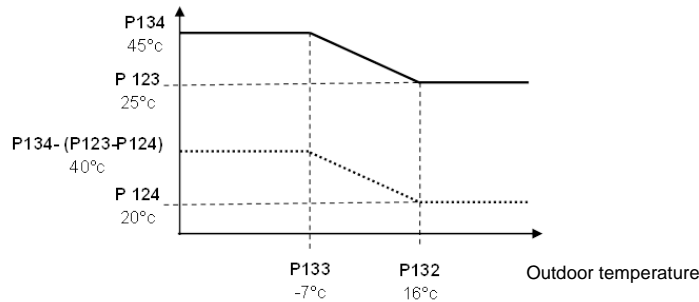

- The maximum setpoint calculated cannot be above 60 °C, regardless of the gradient setting.

### 16.7 Automated self-regulating control

If the compressor runtime drops below 3 minutes, the stage differential is increased by 1.0 K for control on the return line (maximum value of 7.0 K). For control on the supply line, the calculated difference is changed by 1.0 K in order to delay the starting of the compressor. The maximum shift value is 7.0 K for the first stage and 6.5 K for the following stages.

The following message appears:

```

S E L F - R E G U L A T I N G
C O N T R O L   M O D E

```

If the compressor runtime rises above 5 minutes and the automated self-regulating control is on, the stage differential for the control on the return line is lowered by 1.0 K until the initial values are reached. For control on the supply line, the calculated difference by 1.0 K is changed in order to hasten the starting of the compressor until the initial values are reached.

The function is disabled if the initial values are reached, if the unit is turned off (via On/Off button on console or automatic operation control on with winter water loop protection off), if a unit fault occurs, if parameter P141 (control mode) is changed and if a power failure occurs.

### 16.8 Control for bus connection to the Drycooler controller in FREECOOLING mode

The thermodynamic unit can control only the cooling return line because the FREE COOLING module adjusts the cooling capacity using its own return line sensor and by retrieving the setpoint set by the cooling unit controller.

## 17 CONTROL OF CONDENSING PRESSURE FOR AIR-COOLED UNITS

### 17.1 Control during normal operation or on/off control

➤ In heating mode:

All the fan stages are turned on at maximum speed:

- Once a compressor stage is running on the unit when P11 = intertwined
- Once a compressor stage is running on the circuit when P11 = split.

➤ In cooling mode:

- Control mode is turned on as soon as a compressor stage is running on the circuit.

**A) On/Off, where P21 (variable speed control) = No, P10 = Propeller and P11 = Split**

The fans turn on once the compressor on the corresponding circuit starts up.

P180 = 2 or 3 corresponds to 2 or 3 fan stages per circuit.

- Fan 1 on circuit 1 will be controlled by stage 1, motherboard terminal block J3 (terminal 5)

- Fan 2 on circuit 1 will be controlled by stage 2, motherboard terminal block J3 (terminal 6)

- Fan 1 on circuit 2 will be controlled by stage 1 on circuit 2, ADD 2 board terminal block J3 (terminal 5)

- Fan 2 on circuit 2 will be controlled by stage 2 on circuit 2, ADD 2 board terminal block J3 (terminal 6)

1er: stage 1, 2eme: stage 2  
DEE = Interstage differential

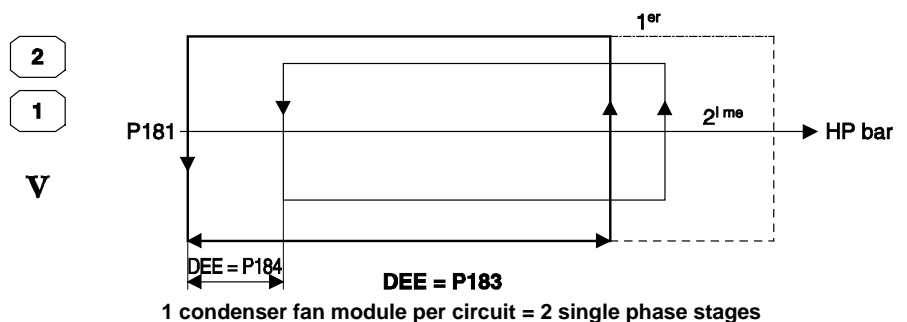

- The two fans 1 on circuit 1 will be controlled by stage 1 on circuit 1, motherboard terminal block J3 (terminal 5)
- Fan 2 on circuit 1 will be controlled by stage 2 on circuit 1, motherboard terminal block J3 (terminal 6)
- Fan 3 on circuit 1 will be controlled by stage 3 on circuit 1, ADD 2 board terminal block J3 (terminal 7)
- The two fans 1 on circuit 2 will be controlled by stage 1 on circuit 2, ADD 2 board terminal block J3 (terminal 5)
- Fan 2 on circuit 2 will be controlled by stage 2 on circuit 2, ADD 2 board terminal block J3 (terminal 6)
- Fan 3 on circuit 2 will be controlled by stage 3 on circuit 2 of the ADD 2 board terminal block J3 (terminal 8)

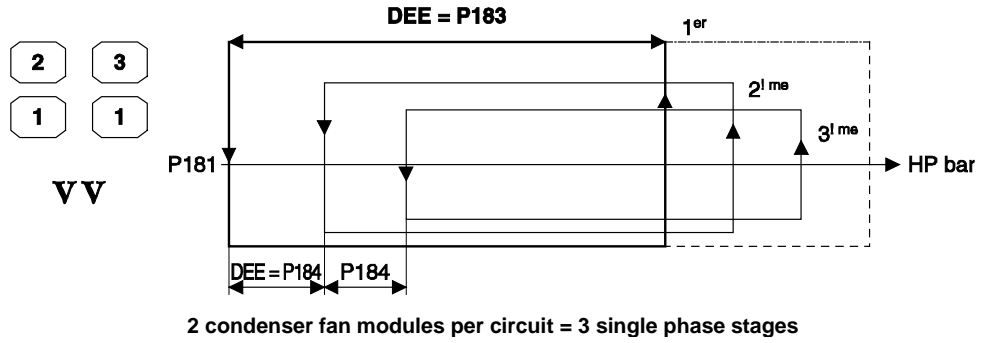

1er = stage 1, 2ème = stage 2, 3ème = stage 3

**B) On/Off, where (P21 = No), P10 = propeller and P11 = intertwined**

- Control mode is turned on as soon as a compressor stage is running on the unit.
- If one of the two circuits is shut off (by a temporary or permanent fault, or control fault or other fault), the fan continues to operate using the pressure from the circuit this is still on.
- When both refrigerating circuits are on, the fans are turned on and off by the circuit with the highest pressure.

Fan 1 will be controlled by stage 1, motherboard terminal block J3 (terminal 5)  
 Fan 2 will be controlled by stage 2, motherboard terminal block J3 (terminal 6)

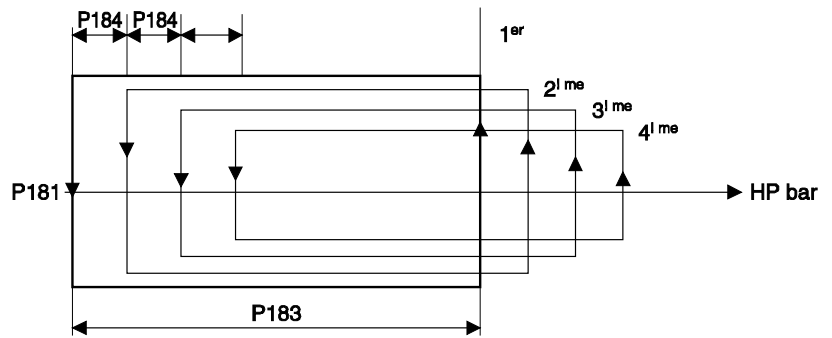

1er = stage 1,  
 2ème = stage 2,  
 3ème = stage 3,  
 4ème = stage 4

**C) On/Off, where (P21 = No), P10 = propeller and P11 = intertwined**

- Control mode is turned on as soon as a compressor stage is running on the unit.
- Stages 1 and 2 are controlled by each circuit.
- Common stage 1 is turned on as soon as the first control stage for circuits 1 and 2 is turned on.
- Common stage 3 is turned on as soon as the third control stage for circuits 1 and 2 is turned on.

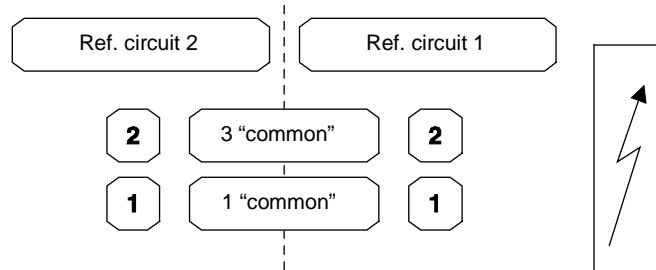

Fan 1 on circuit 1 will be controlled by stage 1, motherboard terminal block J3 (terminal 5)  
 Fan 2 on circuit 1 will be controlled by stage 2, motherboard terminal block J3 (terminal 6)  
 Fan 1 on circuit 2 will be controlled by stage 1 on circuit 2, ADD 2 board terminal block J3 (terminal 5)

Fan 2 on circuit 2 will be controlled by stage 2 on circuit 2, ADD 2 board terminal block J3 (terminal 6)  
 "Common" fan 1 will be controlled by common stage 1, ADD 2 board terminal block J3 (terminal 7)  
 "Common" fan 3 will be controlled by common stage 3, ADD 2 board terminal block J3 (terminal 8)

1er = stage 1,  
 2ème = stage 2,  
 3ème = stage 3,

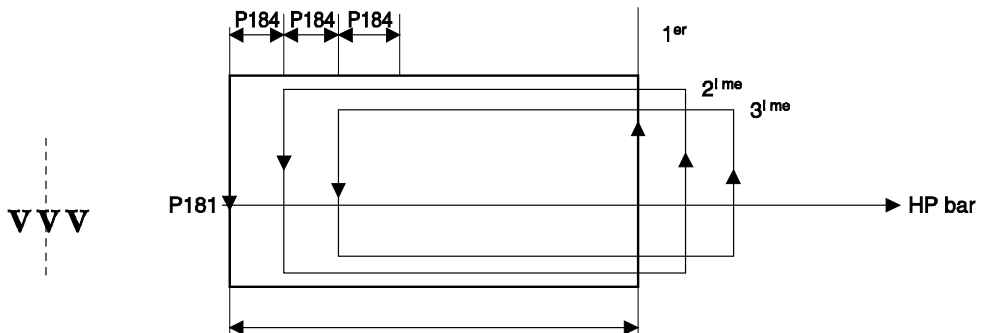

## 17.2 Forced and self-adjusting control

The condensing pressure control can be forced in cooling mode in two cases:

**Case 1:** If  $HP > P54 - P195 - 0.5$ , the fans run at maximum speed for 30 minutes and the stages turn on at 1-second intervals. This 30-minute runtime applies in case 2 as well.

- If intertwined coils are used, the first fan is turned on by the sensor that reads the highest value.

- If split coils are used, the function is managed by each circuit.

- If mixed coils are used, fans 1 and 2 are managed by each circuit. In the case of common fans 1 and 3, they are turned on by the sensor that reads the highest value.

**Case 2:** Management of control stage 1 (case of propeller fans with on/off control).

If fan stage 1 turns on more than 5 times in 10 minutes while the other stages are off, increase the stage differential by 4.5 b to shut off the other stages. Normal control mode resumes (extra 4.5 b pressure eliminated and other stages allowed to turn on) if  $HP > P54 - P195 - P196$  or if  $HP > P181 + P183$  for 10 minutes.

If the common fan 1 stage (common to both circuits) turns on more than 5 times in 10 minutes and the other higher stages on both circuits are off, increase the stage differential by 4.5 b on both circuits.

The following message appears when  $P11 =$  split and mixed if stage 1 or 4 turns on more than 5 times in 10 minutes:

```

H P   P R E S S U R E   C O N T R O L
S T A G E   1   O N L Y
    
```

The following message appears when  $P11 =$  intertwined and mixed if stage 3 turns on more than 5 times in 10 minutes:

```

H P   P R E S S U R E   C O N T R O L
S T A G E   1   O N L Y
    
```

## 17.3 Fan speed control

The speed of the fans is controlled by the HP pressure sensor and the 0-10 V outputs on the motherboard and additional board 2. This control functions in cooling mode only in order to reduce the sound level of the units. In heating mode, the fans run at maximum speed once a compressor stage turns on.

If  $P21 = 2$  or  $3$  (speed control with energy or acoustic optimisation) the speed of fan 1 on each circuit will be controlled; the other fans will be adjusted to  $P180$  by the on/off inputs.

The moment the fan starts in speed control mode and the moment the other stages are turned on must be separated by an interval of 3 seconds.

### Variable speed drive (VSD):

In order for it to adjust the speed based on the 0-10 V signal, the variable speed drive selected must first be supplied electrically and informed of the direction of rotation.

#### > VSD power supply:

Power will be supplied, via the power contactors, by the control for fan 1 on circuit 1 (terminal 5 on terminal block J3), the control for fan 1 on circuit 2 (terminal 6 on terminal block J3 on additional card 2) and the control for fan 1 common to both circuits (terminal 5 on terminal block J3 on additional board 2).

In both **heating** and **cooling** mode, these three outputs must be powered as soon as the unit is turned on by pressing the **On/Off** button on the console or by turning off the Automatic Operation control. They will shut off after the Automatic Operation control is turned on or if the **On/Off** button on the console is pressed.

#### > Authorisation of VSD operation:

External VSDs (ALTIVAR) will not be controlled by the software. Instead, they will be controlled electromechanically via two auxiliary relays on the KGs of the compressors (as soon as a compressor turns on, the associated relay sends the information to the VSD). As a result, running the VSDs without the compressors will not be possible.

In the case of electronically commutated fans (built-in variable speed drive), authorisation for the VSDs to turn on is given by the board when the fan contactor outputs are in the On position (no relay needed).

### 17.3.1 Fan speed control with split coils ( $P11 =$ split):

This configuration requires a variable speed drive for each circuit.

- 0-10 V output, stage 1, circuit 1, terminals 1-2 on motherboard terminal block J2

- 0-10 V output, stage 1, circuit 2, terminals 2-1 on terminal block J6 of additional board 2

Speed control mode is turned on as soon as the circuit is on.

#### a) $P21 = 2$ with acoustic optimisation

1 condenser fan module per circuit  
= 1 stage (1 fan) with speed control  
+ 1 single-speed stage (same as standard)

2 condenser fan modules per circuit  
= 1 stage (2 fans) with speed control  
+ 2 single-speed stages (same as standard)

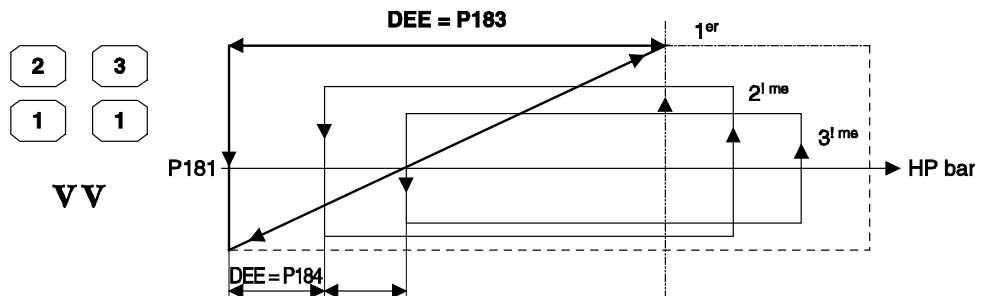

1er = stage 1, 2ème = stage 2,

3ème = stage 3

DEE = Interstage differential

b) P21 = 3 with energy optimisation (Available only if P42 = ALCO or VCM)

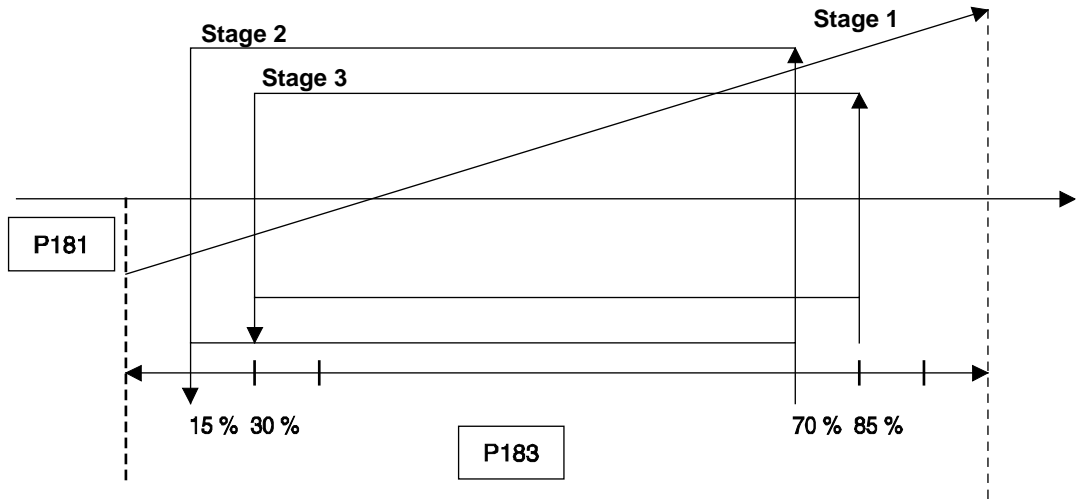

If P180 = 3 stages: 15-30% and 70-85% for stages 2-3  
 If P180 = 2 stages: 20 and 80% for stage 2  
 The values of P181 and P183 must be set.  
 P181 = 17.8 b for R410A, 12 b for R407C, 11.0 b for R22 and  
 In this case parameters P181 and P183 can be adjusted (resolution of 0.1) and parameter P184 becomes needless and therefore inaccessible.  
 The minimum value of P181 becomes 16 bar for R410A.  
 The minimum value of P183 becomes 8 bar for R410A.

6.8 b for R134a  
 P183 = 7.8 b for R410A or 5.5 b for R407C, 5.0 b for R22 and  
 3.8 b for R134a

17.3.2 Fan speed control with intertwined coils (P11 = intertwined):

Speed control mode is turned on as soon as the unit is on.  
 With 1 circuit running: speed is controlled by the circuit's HP sensor.  
 With 2 circuits running: the speed is controlled by the sensor with the highest pressure.

a) P21 = 2 with acoustic optimisation

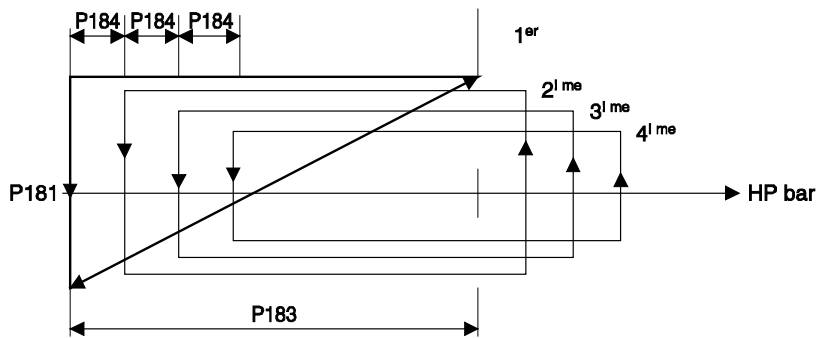

b) P21 = 3 with energy optimisation (Available only if P42 = ALCO or VCM)

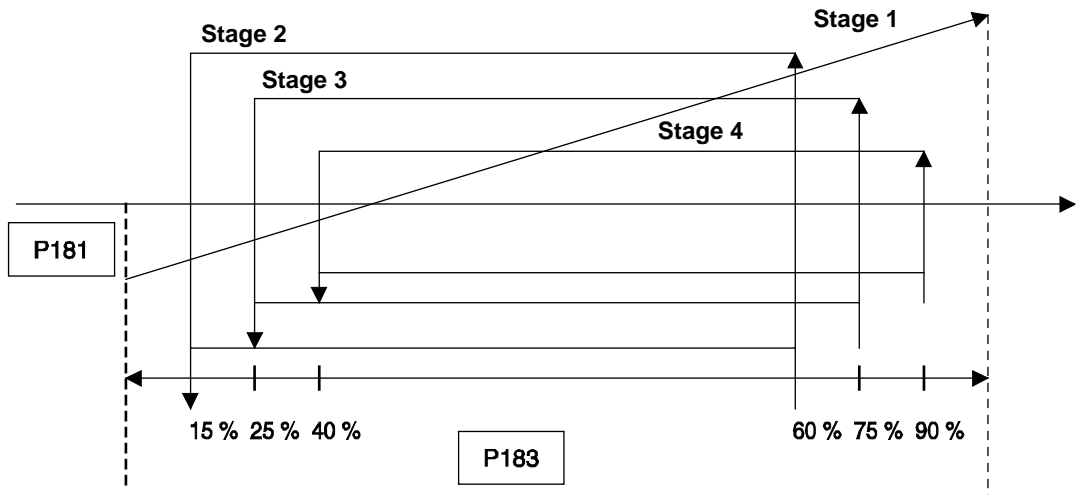

If P180 = 4 stages: 10-25-40% and 60-75-90% for stages 2-3-4  
 If P180 = 3 stages: 15-30% and 70-85% for stages 2-3  
 If P180 = 2 stages: 20 and 80% for stage 2  
 The values of P181 and P183 must be set.

P181 = 17.8 b for R410A, 12 b for R407C, 11 b for R22 and 6.8 for R134a  
 P183 = 7.8b for R410A or 5.5b for R407C, 5.0b for R22 and 3.8 b for R134a

In this case parameters P181 and P183 can be adjusted (resolution of 0.1) and parameter P184 becomes needless and therefore inaccessible.  
 - The minimum value of P181 becomes 16 bar for R410A.  
 - The minimum value of P183 becomes 8 bar for R410A.



### 17.3.3 Fan speed control with mixed coils (P11 = mixed)

- 0-10 V output, stage 1, circuit 1, terminals 1-2 on motherboard terminal block J2
- 0-10 V output, stage 1, circuit 2, terminals 2-1 on terminal block J6 of additional board 2
- 0-10 V output, stage 1 common to circuits 1 and 2, terminals 2-3

of terminal block J6 of additional boards 2

- Common stage 1 is controlled by the highest value of the two signals on circuits 1 and 2
- Common stage 3 is turned on as soon as the third control stage for circuits 1 and 2 is turned on.

#### a) P21 = 2 with acoustic optimisation

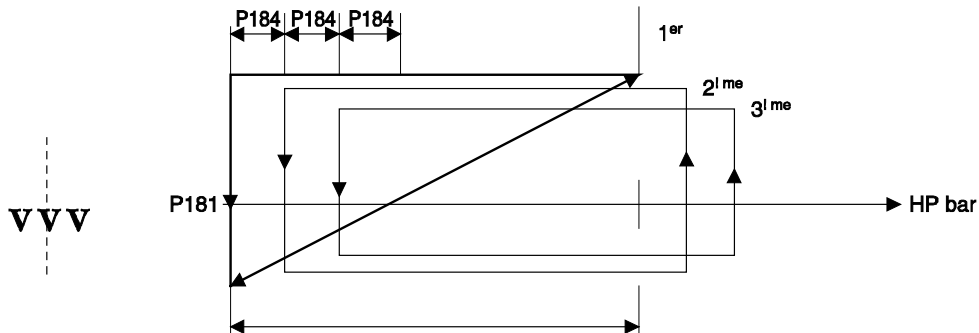

#### b) P21 = 3 with energy optimisation (Available only if P42 = ALCO or VCM)

- If P180 = 3 stages: 15-30% and 70-85% for stages 2-3
- If P180 = 2 stages: 20 and 80% for stage 2
- The values of P181 and P183 must be set.
- P181 = 17.8 b for R410A, 12 b for R407C, 11.0 b for R22 and 6.8 b for R134a
- P183 = 7.8 b if R410A or 5.5 b if R407C, 5.0 b if R22 and 3.8 b

- if R134a
- In this case parameters P181 and P183 can be adjusted (resolution of 0.1) and parameter P184 becomes needless and therefore inaccessible.
- The minimum value of P181 becomes 16 bar for R410A.
- The minimum value of P183 becomes 8 bar for R410A.

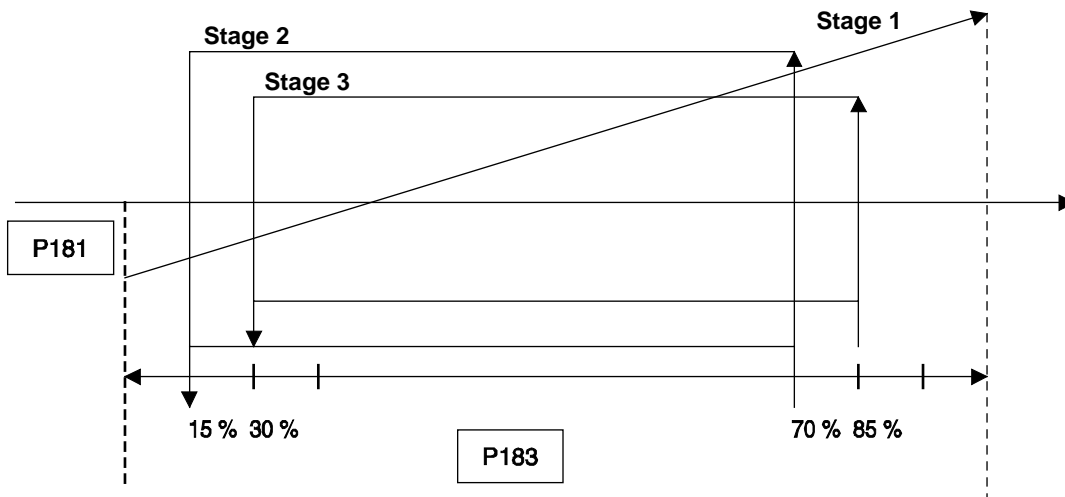

### 17.3.4 Fan speed control if P7 = INVERTER:

- The rotation speed is limited by parameter P192 (default value of 7.8 V). It can be set at between 5 and 10 V (resolution of 0.1 V).
- If P7 = INVERTER, the standard setting value of P181 becomes 13.4 bar as long as LP < 8.3 bar.
- If the LP rises above this value, the HP control setpoint becomes equal to P181 + 4.4 bar.
- The HP control setpoint returns to P181 when the LP drops to < 7.8 bar.
- The maximum shift in the HP STP is 33.9 bar (recovery function included).

### 17.3.5 Forced control of variable-speed fans:

- The condensing pressure control can be forced in cooling mode in two cases:
- If  $HP > P54 - P195 - 0.5$ , the fans run at maximum speed for 30 minutes and the stages turn on at 3-second intervals.
- During defrosting in order to defrost the coils as quickly as

- possible. The HP will have to be as high as possible without turning on the protections.
- Parameter P166 (3 by default) is used to adjust the fan control.

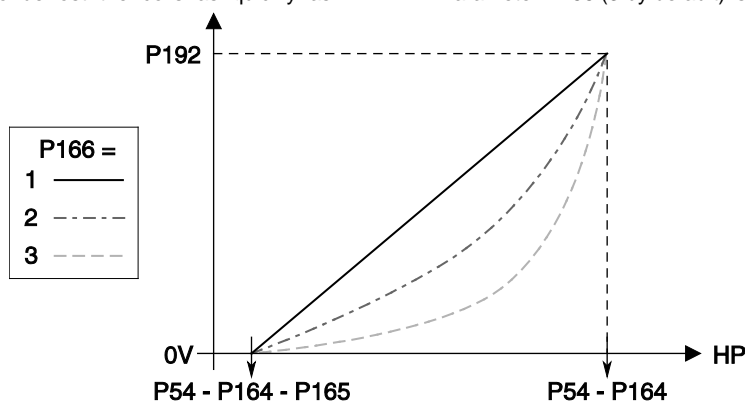

Adjustment adopted during defrosting (once the cycle has been reversed by the reversing valve). The other fans are off during this time.

**17.3.6 Speed control of centrifugal fans (P10 = Centrifugal):**

P21 is hidden. This configuration is not available. The HP is controlled via the air blades. Refer to the section on controlling the air blades.

**17.3.7 Speed control of electronically commutated pressure fans (P10 = Pressure):**

This function provides the same functionalities as the variable speed drive described above with the added possibility of allowing the customer to limit the speed of the fans in order to lower the sound level or best adjust the available pressure.

This function is enabled when:

P10 = pressure P2 = Air-to-Water or Reversible Air-to-Water,  
P180 (No. of HP control stages) = 1 = hidden,

P21 (speed control) = 2 hidden,  
P181 and P183 = visible and P11 (coil type) visible.

In cooling mode, the speed is controlled by the HP pressure sensor and the 0-10 V outputs on the main board. This applies in cooling mode only. In heating mode, the fans run at maximum speed once a compressor stage turns on.

If several electronically controlled fans are on the same circuit, the 0-10 V supplies must be wired in series (two maximum). The speed of the fans is limited by parameter P192 which is set by default to 8 V but may be adjusted to between 5 and 10 V in increments of 0.5 V.

Control:

Regardless of the value of P11, the control system is on as soon as a compressor stage is on.

- One circuit used: The fans are controlled in response to the high pressure on the circuit.

- Two circuits used: The fans are controlled in response to the highest pressure read by either sensor on the two circuits. The fans are controlled simultaneously.

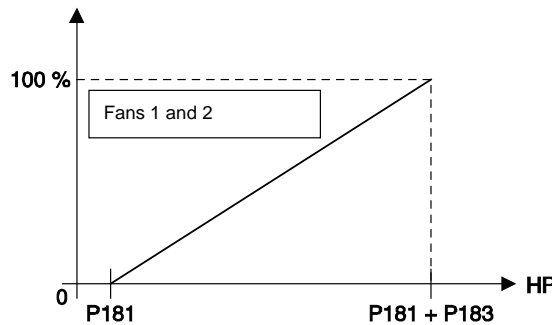

The cases for forced control and control during defrosting are the same as those described in section 17.3.5.

**17.4 Low Noise control (single-fan units only)**

This function is available only on single-fan units, i.e. if P180 = 1. To see if the function is enabled, go to parameter P191 (Low Noise operation), which is set to 'Yes' by default. Visible only if P180 = 1.

This function disappears if a variable speed drive is used (P21 = Yes).

The fan must be shut off when switching from LS to HS and back. To do so, open contact J3, terminal 2 before actuating J3, terminal 3.

LS is obtained by energising fan relay 1 (terminal 2 on terminal block J3) and fan relay 2 remains open.

HS is obtained by energising fan relay 2 (terminal 3 on terminal block J3) and fan relay 1 remains open.

➤ In cooling mode:

**- If P191 (LOW NOISE) = Yes:**

As long as  $HP < P54 - P195 - 3$  b, low speed must remain on. When the HP rises above this value, shift to high speed (cut off terminal 2, terminal block J3; cut off terminal 3 on terminal block J3; restore terminal 2 on terminal block J3). LS is resumed when  $HP < P54 - P195 - 7$  b.

**- If P191 (LOW NOISE) = No:**

The system must be switched to high speed very quickly in order to deliver a maximum amount of power to the customer.

- If  $HP > P181 + P183$ , turn on LS

- If  $HP > P181 + P183 + P184$ , turn on HS

The system does not switch to LS before turning off. It is shut off when  $HP = P181$ .

**- Forced and self-adjusting control:**

**Case1:** On if P64 (optimised frost protection) = No

- If  $HP > P54 - P195 - 0.5$ , the fans are already running at HS unless the frost limiter on the water or refrigerant line is on. In this case, remain at LS and let the HP protection do its job.

**Case2:** Regardless of the value of P191

- If the fan turns on more than 5 times in 10 minutes, increase the stage differential by 4.5 b. Normal control mode resumes (extra 4.5 b pressure eliminated) if  $HP > P54 - P195 - P196$  or if  $HP > P181 + P183$  for 10 minutes.

The following message appears when P180 = 1 and stage 1 turns on more than 5 times in 10 minutes:

H	P	P	R	E	S	S	U	R	E	C	O	N	T	R	O	L
H	P	S	H	I	F	T	E	D								

➤ In heating mode:

The fan runs at HS.

**17.5 Total recovery control**

The total recovery function and its associated parameters (P29 and P193) are accessible only if P2 = air-to-water:

P	2	9	T	O	T	A	L									
R	E	C	O	V	E	R	Y								N	O

- P193 visible If P29 = Yes

**P 1 9 3   H P   S T P   S H I F T**  
**I N   R E C O V E R Y**

Recovery input (10/11 on J6) will be used by the customer to define the operating mode: STANDARD or RECOVERY

**Two operating modes are possible if parameter P29 = Yes:**

Contact J6 - 10/11 on motherboard **open** without recovery:  
 - Standard fans controlled based on the values of P10, P20 and P21

B) Contact J6 - 10/11 motherboard **closed** with recovery:  
 - The turning-on of the fans is shifted using parameter P193 → The HP control setpoint then becomes equal to P181 + P193  
 - The control logic will then be identical to standard control using the values of P10, P20 and P21.

**17.6 Management of the air blades if P10 = Centrifugal**

This "all season" option will be offered for air-to-water units with centrifugal fans.

**- If P20 = Yes:**

➤ **Heating mode:** The centrifugal fan starts up 3 seconds after the compressor, regardless of the HP1 and HP2 values. The fan is turned off during defrosting. The air blades are always open.

➤ **Cooling mode:** The air blades are controlled by the 0-10 V output (terminals 1-2 on terminal block J2 on motherboard) as shown below:

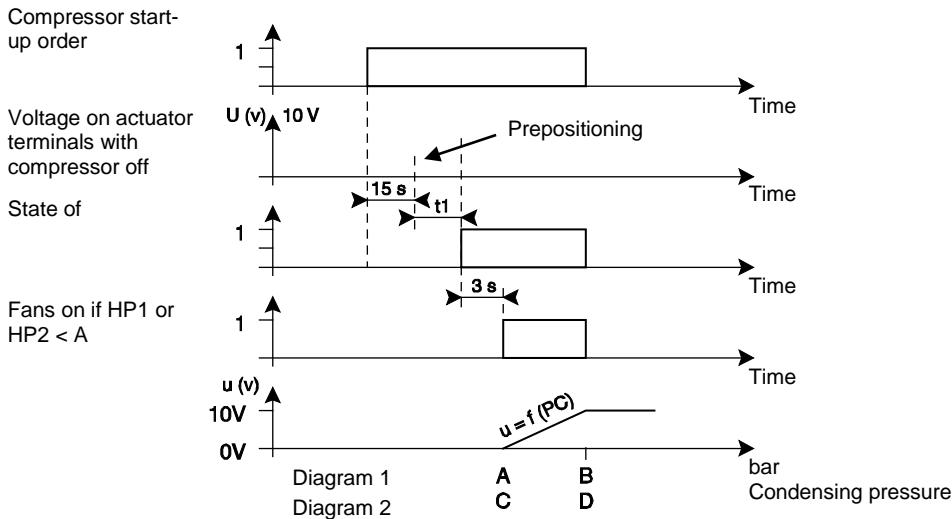

	Diagram 1		Diagram 2	
	Value A	Value B	Value C	Value D
<b>R22/R407C</b>	12b	16b	19b	23b
<b>R134a</b>	7.5b	10.5b	12.5b	15.5b
<b>R404a</b>	14b	18b	20b	23b
<b>R410a</b>	20b	25b	30b	37b

⇒ One-circuit unit (or fault on one circuit of a two-circuit unit):  
 Adjust as shown in diagram 1.

⇒ Two-circuit unit and if the compressor on circuit 2 running for at least 5 seconds:

- If HP1 or HP2 < A → Control shown in diagram 1 and taking into account the sensor with the lowest pressure.
- If A < (HP1 and HP2) < C → Control shown in diagram 1 and taking into account the sensor with the lowest pressure.
- If HP1 or HP2 > C → Control shown in diagram 2 and comparison of:

. Voltage U1 = Diagram 1 (lowest HP)

. Voltage U2 = Diagram 2 (highest HP)

And voltage U adjusted to highest value of U1 and U2.

- If HP1 and HP2 > C → Control shown in diagram 1 and taking into account the sensor with the highest pressure.

**- P20 = No:**

Output = 0 V

## 18 CONTROL OF CONDENSING PRESSURE FOR WATER-TO-WATER UNITS

### 1) Operation with a two-way valve

If municipal wastewater is used to cool the condenser, we recommend installing the two-way valve so as to be able to set the condensing pressure to a value that will ensure correct operation of the unit and save on cooling water.

Set P26 to 'two-way valve'. The valve will open linearly from P197 to P198 based on the high pressure.

For more details, refer to the instruction manual supplied with the kit. To obtain high cooling capacity, set P197 and P198 to their lowest values. To save on water, set P197 and P198 to their highest values.

These adjustments depend solely on your installation. It is essential that you ensure the correct operation of your unit.

### 2) Operation with a three-way valve

We recommend installing our three-way valve kit if our units are used with cooling towers. This valve will allow you to adjust the condensing pressure better and thus optimise your unit's performance. Set P26 to 'three-way valve'. The valve will open linearly from P197 to P198 based on the water return temperature. For more details, refer to the instruction manual supplied with the kit.

## 19 RESTRICTION OF OPERATION OF THE MACHINES BASED ON THE OUTDOOR TEMPERATURE

### 19.1 Restriction to the minimum air temperature in heating mode

```
P 2 2 5 M I N . A I R T E M P . I N
I N H E A T I N G M O D E - x x °
```

- This parameter can be set to between -25°C and 5°C in 1°C increments.

- Default setting: -10°C if P119 ≠ Cooling where P2 = 3 reversible air-to-water and P7 ≠ INVERTER -20°C if P119 ≠ Cooling where P2 = 3 reversible air-to-water and P7 = INVERTER

This function is disabled if at least one circuit is being defrosted.

The thermodynamic unit shuts off once the outdoor temperature ≤ P225. The auxiliary heaters or the boiler are substituted for the thermodynamic control stages. The (thermodynamic) unit restarts once the temperature rises to above P225 + 2K.

**Display in heating mode and if auxiliary electric heater P22 = No and P111 ≠ Boiler:**

```
M A C H I N E O F F I N H T G M O D E
O U T T E M P . T O O L O W
```

➤ If a fault occurs:

- Fault stored in memory in case of a mains power failure
- Fault saved in fault memory
- Relay in On position
- Unit fault LED lit steady.

**Display in heating mode and if auxiliary electric heater P22 = Yes:**

```
E L E C A U X C T R L
O U T T E M P . T O O L O W
```

➤ If a fault occurs:

- Fault not stored in memory if a mains power failure occurs
- Fault not saved in memory if a mains power failure occurs
- Fault relay in Off position
- Unit fault LED off.

**Display in heating mode and if P111 = Boiler:**

```
B O I L E R C O N T R O L
O U T T E M P . T O O L O W
```

➤ If a fault occurs:

- Fault not stored in memory if a mains power failure occurs
- Fault not saved in memory if a mains power failure occurs
- Fault relay in Off position
- Unit fault LED off.

**- To disable this function:**

- Simply press the - button until the maximum value of the parameter appears. Below this value, the following message appears:

```
P 2 2 5 M I N . A I R T E M P .
I N H T G M O D E D I S A B L E D
```

- To turn off the function, simply press **Enter**.

- To re-enable it, simply enter a value of between -25°C and +5°C and press **Enter**.

### 19.2 Restriction to the maximum air temperature in cooling mode

Visible only if P2 = air-to-water or reversible air-to-water and cooling mode

```
P 2 2 5 . 1 M A X . A I R T E M P .
I N C L G M O D E + x x °
```

- This parameter can be set to between 35°C and 50°C in 1°C increments.

- Default setting: DISABLED

The unit shuts off once the outdoor temperature ≥ P225.1.

The unit restarts once the temperature rises back to above P225.1- 2K.

➤ Fault message:

```
M A C H I N E   O F F   I N   C L G   M O D E
O U T   T E M P .   T O O   H I G H
```

➤ If a fault occurs:

- Fault stored in memory in case of a mains power failure
- Fault saved in fault memory
- Relay in On position
- Unit fault LED lit steady.

**To disable this function:**

- Simply press the + button until the maximum value of the parameter appears. Above this value, the following message appears:

```
P 2 2 5 . 1   M A X .   A I R   T E M P .
I N   C L G   M O D E   D I S A B L E D
```

- To turn off the function, simply press **Enter**.
- To re-enable it, simply enter a value of between 35°C and 50°C and press **Enter**.

### 19.3- Restriction to the maximum air temperature in heating mode:

This function is used to prohibit the machine operating in heating mode when the outdoor temperature rises above a configurable value. This function is disabled if at least one circuit is being defrosted

Visible if P2 = water-to-water and reversible air-to-water when P119 ≠ 1 (Cooling only)

```
P 2 2 5 . 2   M A X .   A I R   T E M P .
I N   H E A T I N G   M O D E   - x x °
```

- This parameter can be set to between -5°C and 20°C in 1°C increments.
- Default setting: DISABLED

The unit shuts off once the outdoor temperature ≥ P225.2

The unit restarts once the temperature rises back to above P225.2 - 2K.

➤ Display

```
M A C H I N E   O F F   I N   H T G   M O D E
O U T   T E M P .   T O O   H I G H
```

This limit is not managed as a fault if the machine is shut off because of it:

- Not stored in memory if a mains power failure occurs
- Fault not saved in memory
- Fault relay in Off position
- The unit fault LED is off

To disable this function:

- Simply press the + button until the maximum value of the parameter appears. Below this value, the following message appears:

```
P 2 2 5 . 2   M A X .   A I R   T E M P .
I N   H T G   M O D E   D I S A B L E D
```

- To turn off the function, simply press **Enter**.
- To re-enable it, simply enter a value of between -5°C and +20°C and press **Enter**.

### 19.4- Restriction to the minimum air temperature in cooling mode:

This function is used to prohibit the machine operating in cooling mode when the outdoor temperature rises above a configurable value.

Visible if P2 = Reversible Water-to-Water and Air-to-Water when P119 ≠ 2 (Heating only)

```
P 2 2 5 . 3   M I N .   A I R   T E M P .
I N   C L G   M O D E   + x x °
```

- This parameter can be set to between -20°C and 12°C in 1°C increments.
- Default setting: DISABLED

The unit shuts off once the outdoor temperature ≤ P225.3.

The unit restarts once the temperature rises back to above P225.3 + 2K.

➤ Display

```
M A C H I N E   O F F   I N   C L G   M O D E
O U T   T E M P .   T O O   L O W
```

This limit is not managed as a fault if the machine is shut off because of it:

- Not stored in memory if a mains power failure occurs
- Fault not saved in memory
- Fault relay in Off position
- The unit fault LED is off.

## 20 MANAGEMENT OF THE AUXILIARY HEATER BOARD AND THE ELECTRIC AUXILIARY HEATERS

The auxiliary electric heater board is the additional board 1 with the rotary switch in position 2.  
It is used to obtain up to four additional control stages in heating mode.

### Example:

When used on a unit with two control stages, the board brings the total number of control stages to six (two thermodynamic stages + four electric stages).  
Although the electric stages are managed as control stages, the last control stages will turn on last.

- The electric stages are turned on if:
  - the thermodynamic power is insufficient
  - faults occur on the compressor stages
  - the outdoor temperature is less than P225
  - the water return temperature is too low to allow defrosting
- The electric stages are shut off if a water flow fault occurs.
- The auxiliary electric heater board has three separate on/off inputs:
  - Input 1 additional board 1, use in auxiliary heater terminal block J4 between terminals 2-3 (if the input is open, the electric auxiliary heaters are shut off by fault 1 and the corresponding message appears).
  - Input 2 additional board 1, use in auxiliary heater terminal block J4 between terminals 4-5 (if the input is open, the electric auxiliary heaters are shut off by fault 2 and the corresponding message appears).
  - Input 3 → additional board 1, use in auxiliary electric heater terminal block J4 between terminals 1-2

Value of P113:

- If P113 = DISABLED, the input is disabled regardless of its state.
- If P113 = LOAD SHEDDING, two cases apply:
  - 1) The input is open: the electric auxiliary heaters operate normally
  - 2) The input is closed: the electric auxiliary heaters are turned off
- If P113 = OVERRIDE:
  - 1) The input is open: the thermodynamic stages and the electric auxiliary heaters operate normally
  - 2) The input is closed: the thermodynamic stages are turned off

The outputs always close in the same order (1, 2, 3, 4) and always open in the reverse order (4, 3, 2, 1).

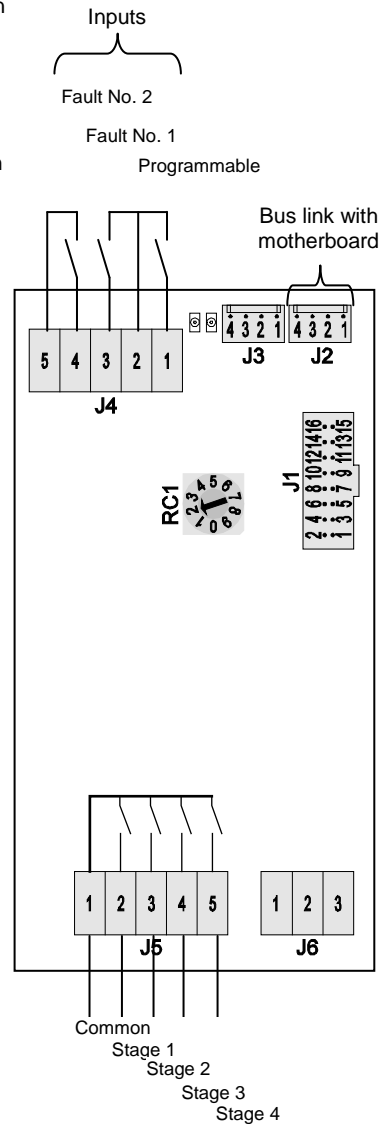

### Management of the electrical auxiliary heaters under normal operation:

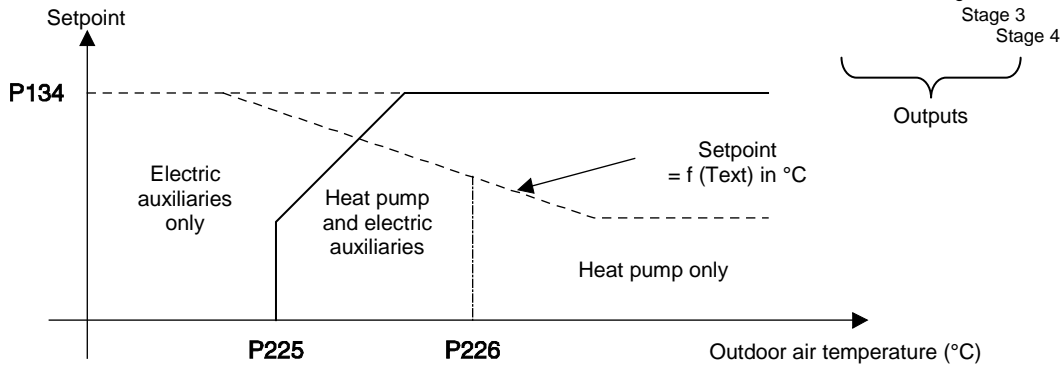

- If the air temperature  $\geq$  P226: heat pump alone
- If the air temperature  $<$  P226: heat pump and electric auxiliary heaters. If a call is made for control, the thermodynamic control stages are the first stages.
- If the air temperature  $<$  P225: the heat pump is shut off and only the electric stages operate.

### Management of the electric auxiliary heaters when the thermodynamic control stage is shut off by a setpoint corrected by the discharge protection:

- The electric stages take the place of the thermodynamic stages and become the first control stages, and the outdoor air temperature at that exact moment is stored in memory.
- The auxiliary heaters are set to the initial setpoint if P131 (setpoint adjustment based on outdoor temperature) = No. They are set to the calculated setpoint if P131 = Yes.
- The thermodynamic stages adjust to the setpoint corrected by the discharge temperature protection.
- Whether the machine is on or off, the corrected setpoint will

increase by 1°C for an equivalent rise in the air temperature until:

- . Initial setpoint if P131 = No
- . Calculated setpoint if P131 = Yes
- When the air temperature is  $>$  than the air temperature stored in memory + 2, the thermodynamic stages revert to being the first control stages and the electric stages are the last and adjust to the original setpoint:
  - . Initial setpoint if P131 = No
  - . Calculated setpoint if P131 = Yes

### Management of the electric auxiliary heaters when the machine is shut off by a general fault:

The electric stages take the place of the thermodynamic stages.

## 21 MANAGEMENT OF THE BACK-UP BOILER

If P111 = Boiler

➤ Management under normal operation:

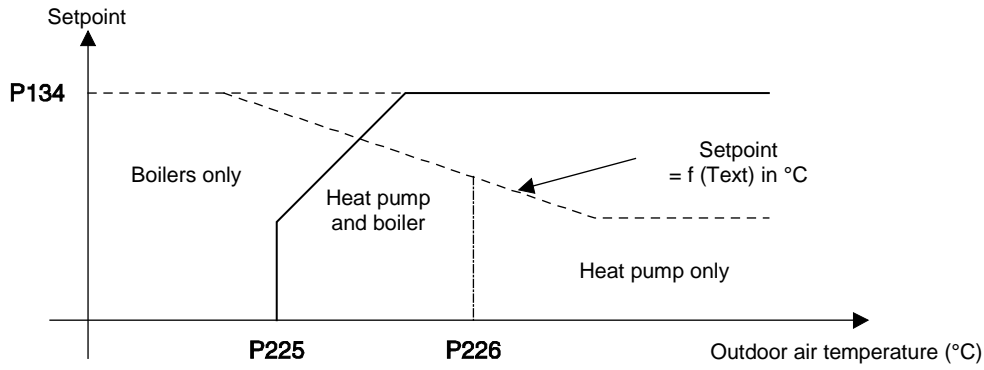

- If the air temperature  $\geq$  P226: heat pump alone
- If the air temperature  $<$  P226: heat pump and boiler. If a call is made for control. The thermodynamic control stages are the

- first stages.
- If the air temperature  $<$  P225: heat pump shut off and boiler turned on.

➤ **Management of the electric auxiliary heaters when the thermodynamic control stage is shut off by a setpoint corrected by the discharge protection:**

- The boiler contact (terminals 9-10 on terminal block J3 on the main board) is closed, the outdoor air temperature at the time of closing is stored in memory. P226 takes on the value of the outdoor temperature if it is lower.
- The boiler is set to the initial setpoint if P131 (setpoint adjustment based on outdoor temperature) = No. It is to the calculated setpoint if P131 = Yes
- The thermodynamic stages adjust to the setpoint

- corrected by the discharge temperature protection
- Whether the machine is on or off, the corrected setpoint will increase by 1°C for an equivalent rise in the air temperature until:
  - . Initial setpoint if P131 = No
  - . Calculated setpoint if P131 = Yes
- The boiler relay is open when the air temperature  $>$  P226 + 2.

➤ **Management of the boiler when the machine has been shut off by a general fault:**

- Boiler contact closed
- Control with P135 = 50°C as minimum setpoint

- by default, this minimum setpoint must be adjusted based on the technology of the boiler.

➤ **Management of the boiler when the machine has been shut off by a water flow fault:**

(Depending on state of P27: pump controlled by boiler operation)

- If P27 = Yes, boiler operation authorised.

- If P27 = No, the boiler is shut off.

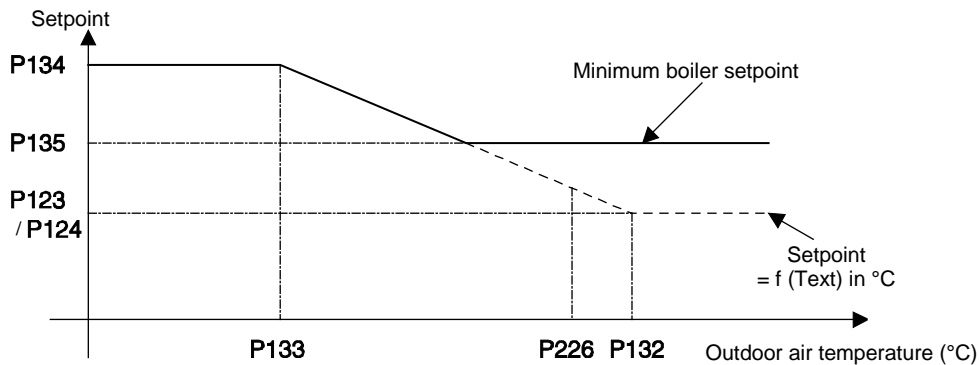

## 22 MASTER/SLAVE CONTROL

### 22.1 Case of two parallel-connected machines

For a master/slave setup involving two parallel-connected machines, the machines must be connected by a bus link and one must be designated as the master machine in control of the slave machine.

Menu 12 (Master/Slave) appears when parameter P28 is set to 'Yes'.

1 2 - M A S T E R / S L A V E

➤ Designation of master machine:

P 8 0 0 M A S T E R M A C H I N E  
O N L O O P Y E S

**Important:**

only one machine may be configured as the master on each loop. If the master machine has already been configured and you try to configure the slave machine as the master, the slave machine's parameter will be locked and not be accessible. Parameter P808 sets the minimum time delay between the turning-on of machines 1 and 2.

**22.1.1 Operating principle:**

The master machine sends the following information to the slave machine:

- ON-OFF.
- Heating/cooling mode

The master machine will not have access to detailed information about the slave machine (fault details, operating readings, machine parameters, operating parameters, etc.) and vice versa.

If a BMS is used, each machine will have access to all the information on the other machine.

**The control temperature is measured on the machine that operates first, which may be a the master or the slave, depending on availability**

**Important:**

The master machine's BMS link manages information from the loop and the master machine. To obtain information on the slave machine, its BMS link must be connected.

➤ Loop description:

- The loop is limited to two units. Both may be assigned to the loop's operation or one may be assigned as a backup.
- The loop may be controlled in either heating or cooling mode. Switching between modes is managed in the same way as when a

- single machine is running (no master/slave control).
- Each machine will be adjusted by its own software and the adjustments made to the master machine will control the units on the loop in cascade mode.

**22.1.2 General:**

In all cases, the slave machine's On/Off button can be used to cut the master machine's control over the slave machine.

Once a machine is configured as the master, it has control over the slave machine.

The machine with the most control stages must always be designated as the master machine.

The slave machine's control parameters become locked when P28 = Yes.

The time on the master machine's console is sent to the slave machine so that both have the same time.

If communication between the master and slave machine is lost for more than two minutes, the slave machine switches to independent operation with its own information and displays the following message:

L I N K F A U L T  
L I N K F A U L T

➤ Automatic acknowledgment:

- The automatic operation controls are managed by each machine as if the machines were not linked.
- Load shedding via the on/off inputs is managed by each machine as if the machines were not linked.
- The pumps are also managed by each machine as if the machines were not linked.

Parameters P801 to P810 are hidden if P800 = No (i.e. on the slave machine).

**22.1.3 Management of the functions:**

**A) Machine operation priority and balancing of runtimes:**

- The order in which machines are started is determined based on faults and the number of hours of operation.
- **A machine is available** when it is off, has no faults, and is authorised to operated.
- The first machine to start is one that is available and has the fewest hours of operation.

➤ Balancing of runtimes:

- After every 50 hours of machine operation, the system switches to the machine which has operated the least in order to balance the runtimes.
- While the system is on (and before it is shut off), compare the time counters of the machines that are running and change the order number so that the machine with the longest runtime is shut off first.

- If a fault occurs on an active stage (or the stage is forced off), stage "n" becomes "n-1".
- Stages are shut off in the reverse order that they were turned on regardless of their number of hours of operation.
- The total runtime of each machine calculated by adding P285 and P286 on each machine.

**B) Backup or auxiliary machine (P801 = Yes):**

➤ Without changeover:

The backup machine is designated by the customer (P803 = x).

**WARNING:** In this configuration, the customer will have to run this machine twice a year to prevent the pump from seizing.

➤ With changeover:

- The machine with the longest runtime and which is off is automatically set as the backup.
- If a partial fault occurs on a machine on the loop, that machine is automatically made the backup.

- If parameter P807 ≠ 0, the backup machine also serves as the auxiliary machine. It is started up if the temperature >setpoint + P807, and stopped at 1 K below this value.

➤ The backup machine may operate if:

- A machine has a link fault
- A machine has a total fault

- Operation of backup authorised if P807 ≠ 0 and temperature > setpoint + P807



On the backup machine the pumps are off, the LED flashes on and off at 1-second intervals and the following message is displayed:

M U L T I U N I T M A N A G E M E N T  
B A C K U P M A C H I N E

**C) Forced stop of machines:**

This function can be configured to prevent a machine from operating. This selection is enabled by configuration.

**D) Water loop winter protection:**

If parameter P142 on the master machine = Yes

➤ In heating mode:

- This function is possible if P142 on the master machine = Yes, if the automatic operation control inputs on both machines are open, and both machines are set to On. The function must maintain the water inlet temperature on the heat exchanger at 30°C as soon as the outdoor temperature ≤ 3°C (2 K differential = pump and compressors shut off immediately)(Cascade control on the return

line).

- Adjust water-to-water units to the hot water sensor.

- The heating LED is lit; the On/Off LED flashes.

- If a fault occurs on the outdoor sensor, maintain the water loop at 30°C.

Corresponding message on each machine:

M A I N T A I N W A T E R L O O P  
T E M P E R A T U R E A T 3 0 °

➤ In cooling mode:

- This function is possible if P142 on the master machine = Yes, the units are set to On, and the automatic operation control inputs on both machines are open. In this mode, the pump is turned on

when the outdoor temperature ≤ P220 and shut off at P220 + P222.

Corresponding message on both machines:

W A T E R C I R C U L A T I O N  
P U M P F O R C E D O N

If a fault occurs on the outdoor temperature sensor, the pump is forced on.

**Note regarding the circulation of water during freezing weather:** the customer must install a bypass so as to avoid creating a temperature problem during use.

**22.1.4 Controls:**

➤ Operating mode:

Note: The slave machine's operation is determined by the master unit (P119). If P28 = Yes, its operation cannot be changed via the corresponding on/off input, via the console or because of the outdoor temperature.

If the slave machine has a different P119 value than the master machine (e.g. master set to cooling/heating while slave set to cooling only) and a call is made for the slave to operate in a different mode than the master, the slave machine is shut off and the following message is displayed:

S L A V E F A U L T  
P 1 1 9 O P E R A T I N G M O D E

The machine is then shut off.

➤ Control setpoint calculation:

The control setpoint is set by the master machine. If a fault occurs on the master machine, the slave machine operates using its own setpoint and its own sensors.

Return control (P141 = 1 on master machine):

- The control sensor used is on the master machine. If it is shut off (On/Off by automatic operation controls) or a fault has occurred on

it, the slave machine will operate using its own setpoint and its own sensors.

Supply control (P141 = 3 on master machine):

- A sensor must be added to the water outlet manifold connecting both machines. To do so, the sensor must be connected to the slave machine in place of the water inlet sensor on this machine (terminals 2-3 on terminal block 7 of the motherboard).

- The control temperature is sent by the slave machine connected to the water inlet on the slave's heat exchanger.

- The manifold water outlet temperature is the water outlet temperature on the master machine's manifold.

- The water inlet temperature on the slave's heat exchanger is the temperature from the master machine, including in parameter P255.

- The water outlet temperature on the slave's manifold is the temperature of the water outlet on the slave's manifold.

**A) Cascade control:**

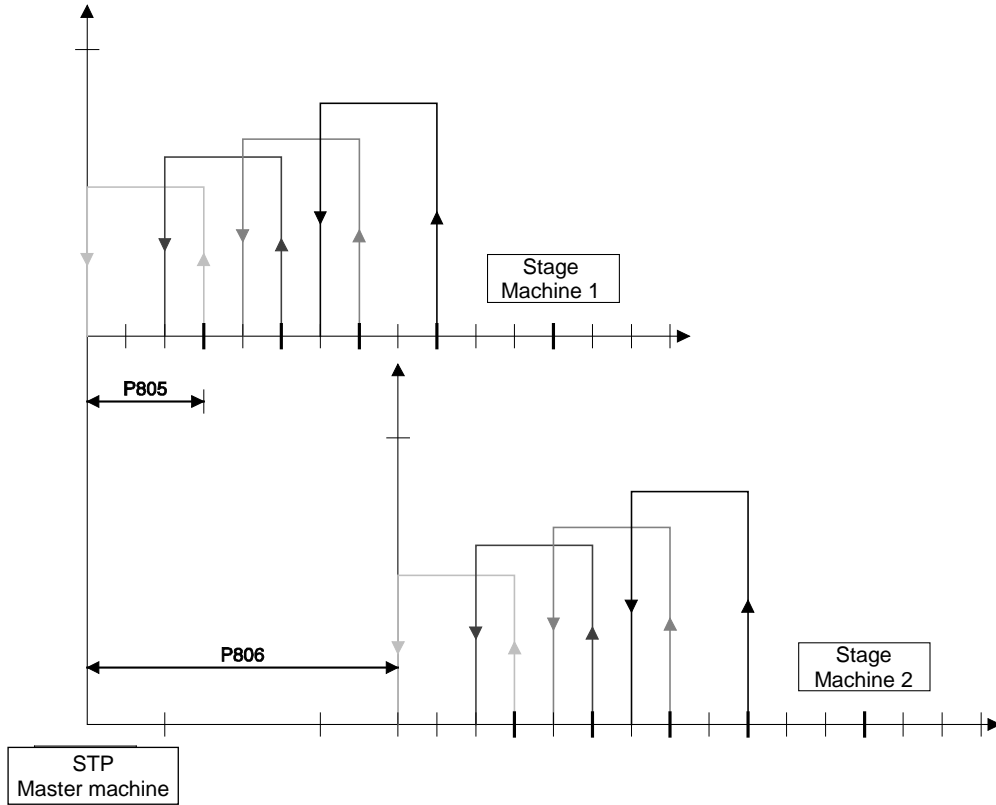

**Note:** P804 = Cascade → parameter P143 on each machine becomes equal to 1°C. This is because the interstage differential on each machine will be adjusted by the value of P143 on each machine. Machine 2's setpoint is shifted by P806 relative to machine 1's setpoint. The value of P806 will have to be selected based on machine 1 in order to achieve an operating order similar to the start-up of the last stage (see figure above).{

**B) Control in parallel with "shifted setpoint":**

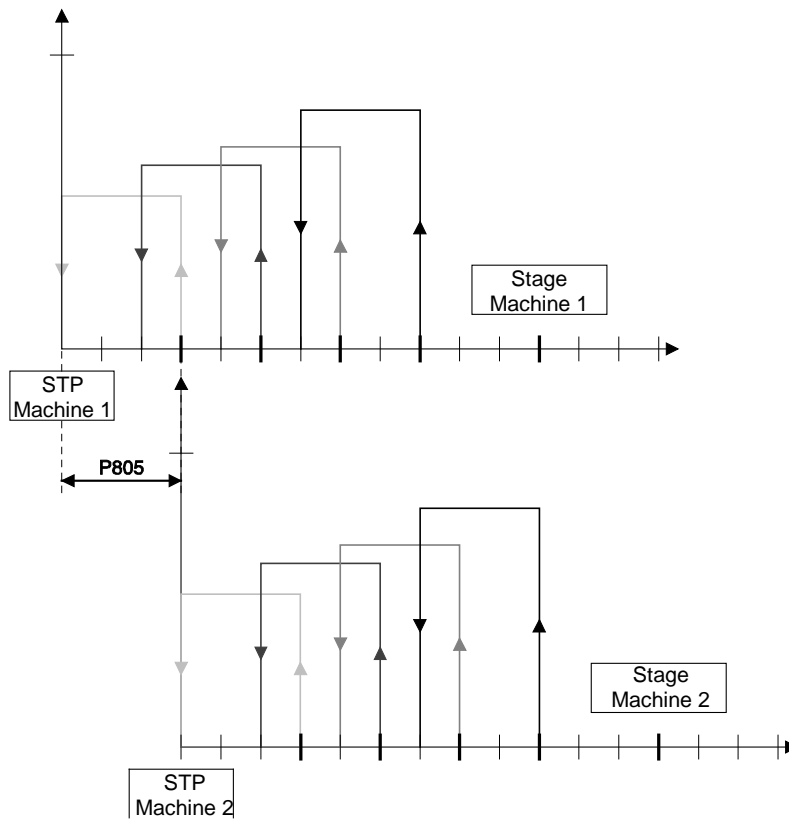

Machine 1 adjusts itself to the master machine's setpoint. Machine 2's setpoint is shifted by the value of P805. Thus, the machine 2's setpoint 2 is machine 1's setpoint + P805.

**C) Water return control for storage (P154 on master machine = Yes):**

This type of control makes it possible to generate maximum capacity at a given time, often when electricity is cheapest. Both machines are turned on at an interstage time delay of 10 seconds when P122 + P155 is achieved. The machines are shut off at P122 at an interstage time delay of 1 second.

- If P154 = Yes, storage control is enabled and the control mode based on the selected setpoint is controlled by the master machine.

Cascade control is used by default for both machines when setpoint 1 selected (standard control).

The 'Yes' value of P154 on the slave machine becomes inaccessible if P28 = Yes.

**D) Hourly scheduling:**

If P27 = Yes, the hourly schedules of two parallel-connected machines will be controlled by the control parameters on the master machine and the hourly schedule on the slave machine will become inaccessible.

**22.1.5 Machine status menu:**

If there are no general faults and the automatic operation inputs are closed, a submenu (overrides the fault message) is added to the machine status menu:

```
M A S T E R   S L A V E   C T R L
M A S T E R   M A C H I N E
S L A V E   M A C H I N E
```

**23 ACTUATION OF THE ELECTRONIC EXPANSION VALVE**

**23.1 With Alco driver and display**

Only fault feedback signals from the valve are managed in this case

**23.2 With VCM driver**

This configuration corresponds to using the electronic expansion valve with the VCM expansion board and on which the ALCO EXV miniboard with the software is connected.

When P42 is set to this value, the control and view parameters for the Alco electronic expansion valve can be accessed.

The compressor on/off signals authorising the expansion valve to move, as well as the low temperature and suction temperature signals, will be transmitted over a bus link.

**23.2.1 Menus if P42 = VCM:**

➤ Main menu:

```
1 0 - E L E C   E X P .   V A L V E
```

➤ Electronic expansion valve configuration menu:

```
P 6 0 1   C I R C U I T   1
V A L V E   T Y P E           E X 4
```

```
P 6 0 2   C I R C U I T   1
S U P E R H E A T   S T P       6 ° C
```

```
P 6 0 3   C I R C U I T   1
M O P   P O I N T           Y E S
```

```
P 6 0 4   C I R C U I T   1
M O P   V A L U E           1 5 ° C
```

```
P 6 0 5   O P N G   C 1   E X V
S T A R T   A I R   C O N   X X X %
```

```
P 6 0 6   O P N G   C 1   E X V
S T A R T   H E A T   P U M P   X X X %
```

```
P 6 0 7   O P E N I N G   T I M E
S T A R T - U P   C I R C U I T   1   X X S
```

```
P 6 0 8   S L O W   M O D E
C I R C U I T   1   E X V           N O
```

```
P 6 1 1   C I R C U I T   2
V A L V E   T Y P E           E X 4
```

P 6 1 2	C I R C U I T	2		
S U P E R H E A T	S T P		6 ° C	
P 6 1 3	C I R C U I T	2		
M O P	P O I N T		Y E S	
P 6 1 4	C I R C U I T	2		
M O P	V A L U E		1 5 ° C	
P 6 1 5	O P N G	C 2	E X V	
S T A R T	A I R	C O N	X X X %	
P 6 1 6	O P N G	C 2	E X V	
S T A R T	H E A T	P U M P	X X X %	
P 6 1 7	O P E N I N G	T I M E		
S T A R T - U P	C 2			X X S
P 6 1 8	C I R C U I T	2		
S L O W	M O D E			N O

Parameters P608 and P618 are visible only if P2 ≠ reversible air-to-water

➤ Operation parameters:

P 3 2 5	C 1	E X V		
O P E N I N G			X X X %	
P 3 5 5	C 2	E X V		
O P E N I N G			X X X %	
P 5 5 8	C I R 1	E X V	V E R S I O N	
N O .	X X . Y Y	V C M	X X . Y Y	
P 5 5 9	C I R 2	E X V	V E R S I O N	
N O .	X X . Y Y	V C M	X X . Y Y	

### 23.2. 2 Manual EXPANSION VALVE MODE if P42 = VCM:

If Test Mode is set to 'Yes' it retains all standard testing functionalities and provides access to the manual override menu for the electronic expansion valves when – is pressed.

➤ Manual override of expansion valves (opening and closing)

If P3 = 1, access to EXV TEST.1 mode only.

Press + and – to change expansion valves.

➤ Display:

E X V	T E S T . 1
E X V	T E S T . 2

When either test mode is confirmed (OK), access to the settings menu is provided.

➤ Display:

E X V	T E S T	C X
A U T O		

The expansion valve remains in automatic mode the entire time AUTO is displayed. To enter settings mode, press OK.

- To send a signal to open the valve, press + → The percentage immediately higher than the percentage of opening requested by the controller will appear.

- To send a signal to close the valve, press – → The percentage immediately lower than the percentage of opening requested by the controller will appear.

To adjust the valve's percentage of opening to the desired value, press + and –. This percentage can be changed in increments of 1%.

➤ Display:

E	X	V	T	E	S	T	C	X	
O	P	E	N	I	N	G	X	X	%

To exit manual

mode, press **Reset**.

The expansion valve will automatically return to automatic mode if no buttons are pressed on the console for 15 minutes.

### 23.2.3 Control of electronic expansion valve at start-up if P42 = VCM:

➤ Comment:

- The expansion valve's percentage of opening and slow mode (set to 'No') are forced when the compressor is turned on.
- The percentage of opening values in air conditioning and heat pump modes as well as the forcing time can be adjusted using their corresponding parameters.

### 23.2.4 Control of the LP sensor:

➤ If P42 = VCM:

- The LP sensor fault has a time delay of 120 seconds at power-up. It is not taken into account when the unit is off or at the end of the defrosting cycle during pressure balancing.
- The default value of P36 and P38 becomes 17.3 b.

## 24 IMPORTANT INFORMATION REGARDING THE CONTROL OF AN INVERTER COMPRESSOR

- Parameters P195 ( $\Delta P$  for power reduction) and P144 (interstage differential) are visible even though there is just one compressor. P144 (interstage differential) has an adjustment range of 0.5 to 10°C.
- Parameters P145, P146, P147 and P148 are hidden if P7 = INVERTER and supply control is selected. On the other hand, when P141 = supply or return, parameters P143 and P144 remain visible and are set to a default value of 1.5°C.
- Output 3 (stage 2, circuit) on terminal block J3 on the motherboard is used to inform the variable speed drive of any faults requiring the compressor to be shut off. As a result, the compressor will be shut off if a fault is detected (the contact opens).
- Start-up time delay: P66 (Visible only if P7 = INVERTER. Default value of 120 seconds. Adjustable between 0 to 300 seconds in 30-second increments). This time delay corresponds to the minimum time allowed for the compressor control voltage to reach its maximum value of 10 V (value corresponding to the compressor's 90 Hz frequency). In other terms, the compressor will not reach 90 Hz until the end of this time delay even if it is requested to do so by the network's heat load.
- Parameter P192 (maximum fan speed threshold) becomes visible. Its default value is 8.0 V.
- The order in which the compressors turn on and off will be given via output 2 on terminal block J3 on the motherboard (stage 1, circuit 1).
- The compressor speed will be adjusted by an 0-10 V modulating signal (output 2-3 on terminal block J2 on the motherboard).

The following protections are enabled only if P7 = INVERTER:

These limitations are due to the compressor technology.

#### A) If the evaporating temperature drops to or below -20°C for 1 minute:

The minimum frequency in both heating mode and cooling mode becomes 50 Hz until the evaporating temperature rises to or above -15°C for 1 minute.

#### B) If the condensing temperature rises to or above 60°C for 1 minute:

The minimum frequency in both heating mode and cooling mode becomes 50 Hz until the condensing temperature rises to or above 58°C for 1 minute.

#### C) Maximum pressure difference:

##### - During water heating:

If  $HP \geq 4 \times LP + 13.5$ , 120 seconds after start-up, the controller adjusts the control setpoint so as not to push the compressors near their limits too often.

If necessary, a coil defrosting cycle will be forced on.

➤ Information message:

U	N	I	T	$\Delta P$	b	a	r	L	I	M	I	T					
O	P	T	I	M	I	S	E	D	O	P	E	R	A	T	I	O	N

##### - During water chilling:

If  $HP \geq 4 \times LP + 13.6$ , the unit reduces its power by either reducing the compressor speed to 50 Hz or by turning off the compressor.

➤ Information message:

C	P	D	E	L	T	A	L	I	M	I	T					
P	W	R	R	E	D	U	C	T	I	O	N	x	x	m	i	n

➤ Fault function: (enabled in cooling mode and heating mode)

Operation:

The max.  $\Delta p$  threshold is set at  $HP \times 4 + BP + 15.6$

#### If this fault causes at least 5 shutdowns in 24 hours:

- Corresponding circuit shut off.
- 30 min. time delay (in seconds in test mode)
- Fault output off
- Circuit fault LED on console flashes.

F	A	U	L	T	D	E	L	T	A	P	x	x	m	n
X	C	U	T	(	S	)	I	N	2	4	H			

**If this fault causes more than 5 shutdowns in 24 hours:**

- Corresponding circuit shut off.
- Fault output on

- Circuit fault LED on console lit steady.

```
C I R C U I T   B R E A K   x
C P   D E L T A   P   F A U L T
```

**D) Compressor driver fault:**

Terminals 2-3 on terminal block J5 on the controller motherboard receive signals indicating faults on the Danfoss compress driver. Only alarms that shut down the compressor are received.

When contact 4-6 on the driver opens, the driver is in alarm mode. The following message should appear on the controller-console: This function is activated 5 seconds after the power is turned on.

```
M A C H I N E   O F F
O U T   T E M P .   T O O   L O W
```

- Compressor shut off
- Automatic acknowledgement
- Fault stored in memory in case of a mains power failure
- Fault saved in fault memory

- Relay in On position
- Compressor driver fault relay on relay board in On position
- General fault LED lit steady

**25 DEFROSTING OF THE EVAPORATOR COILS**

**An optimised frosting control system has been developed.**

Called DEGIPAC (P159 = optimised), it defrosts the evaporator coils only when frost has actually formed on them instead of based on the frosting time (P159 = fixed). It does so by continuously monitoring the difference in temperature between the coil and the outdoor air. If this difference is abnormally high, it turns on the

defrost cycle. DEGIPAC makes it possible to continue producing hot water for hours during cold, dry weather without having to defrost the coils. As a result, it improves the seasonal COP. Parameter P161 is used to advance (if P161 < default value) or delay (if P161 > default value) the start of the defrost cycle.

- Defrost cycle for reversible machines with **split** circuits (where P2 = 3 and P11 = split)

The defrost cycle is turned on when any of the following occur: The discharge temperature is too high (see discharge protection in heating mode);

Ice is detected on the coil by the sensors on the coils. In this case, defrosting is performed by only one circuit at a time to ensure a minimum supply of hot water for the system;

A difference in pressure, where HP > LP +13.5 for 120 seconds if INVERTER compressors are used.

- Defrost cycle for reversible machines with **intertwined** or **mixed** circuits (where P2 = reversible air-to-water and P11 = intertwined or mixed). In this case, defrosting is performed by both circuits at the same time.

Defrosting is possible only when the water return temperature is high enough to ensure that the heat exchanger will not freeze when the cycle is reversed.

Defrosting is triggered by the low-pressure sensor that reads the lowest value.

```
C I R C U I T   X   B E I N G
D E F R O S T E D
```

- If this temperature is too low (< P52 + 8 K if there are 2 compressors per circuit and < P52+16 K if there is 1 compressor per circuit) and there is no way to increase it, the unit will shut off, save the fault in memory, and display the following message:

```
C I R C U I T   B R E A K   x
D E F R O S T I N G   I M P O S S I B L E
```

- If the temperature can be raised via the second circuit, a boiler or electric auxiliary heaters, the following message will appear:

```
W A T E R   T E M P .   R I S I N G
F O R   D E F R O S T I N G
```

- If this temperature exceeds 26°C, the circuit rises to maximum temperature before the four-way valve reverses and stays at maximum temperature during defrosting in order to minimise the defrosting time.

- If this temperature drops below 26°C, the circuit rises to maximum temperature before the four-way valve reverses and lowers in temperature during defrosting to prevent frost from forming on the heat exchanger.

**Note:** During the defrosting cycle, the controller continuously monitors the temperatures and pressures to prevent frost from forming on the heat exchanger and thus turning on the protections.

This is why the fans may turn on in reverse for certain machine sizes and in normal direction during a defrosting cycle.

**26 HOURLY PROGRAMMING**

**26.1 Presentation**

This function allows the weekly management of liquid chillers by selecting:

- 6 programming stages (maxi).
- 6 holidays zones (maxi).

## 26.2 Definition of the programming stages

### Settings:

Starting time

Ending time

Selected days (M.T.W.T.F.S.S.)

Type of regulation: Setting 1 – Stop/Setting 2 – Stop/setting 1 – setting 2 / setting 2 – setting 1/non valid.

### Setting by fault:

Starting hour: 0h00

Ending hour: 0h00

Validated days: none

Type of regulation not validated.

## 26.3 Definition of holiday zones

### Settings:

Type of zone: non valid, stop, running on setting 1, running on setting 2.

Starting date dd-mm

Ending date dd-mm

Setting by fault Non valid, from 01-01 to 01-01

## 26.4 Operation

When putting under voltage or when setting the time, the information on the machine status are updated as a function of the programming settings.

The user can change the status of his unit (Run/Stop – ½ setting regulation) but if a time range or a holiday zone is active, the information will be updated at the starting or ending time of the programming

In the case where at least one time range or one holiday zone is validated, the parameter P120 is forced on « 2 per console or BMS » and cannot be modified.

When going under test mode, the programming becomes non active. When leaving the test mode, the unit status information are updated as a function of the programming settings.

In case of range overlapping, the running mode has priority over the stop mode and setting 1 over setting 2.

Same thing in case of overlapping of zones.

If a programme stage is active (# non validated) and the real day is selected, the status of the unit is as follows:

Type of programme	Status before starting time	Status before starting time and ending time	Status after ending time
CSG1 -stop	Off	Running on setting 1	Off
CSG2 -stop	Off	Running on setting 2	Off
STP1-STP2	Running on setting 2	Running on setting 1	Running on setting 2
STP2-STP1	Running on setting 1	Running on setting 2	Running on setting 1

If at least one time range or one holiday zone is validated, alternate the message machine stopped or setting/temp with a message in order to signal to the user that the status will be updated on next status change of time range. Display of each of these messages for 3 seconds.

### Message to be displayed:

```

H O U R L Y   P R O G R A M M I N G
O N
  
```

### Access principle:

Through menu 9: "9 PROGRAMMING"

```

9 - P R O G R A M M I N G
  
```

-If validated by key menus "HOURLY PROGRAMMING" and "HOLIDAY ZONES" appear.

"ENTER", 2 sub-

```

T I M E T A B L E
D A Y S   O F F
  
```

Through keys + and – , select one of the 2 sub- menus, then validate with "ENTER"

### Position of the cursor:

When surfing in the various menus, the cursor is located at the top, on the left.

For modifying the settings, it is located at the bottom right side, last but one character.

- When entering the « TIME RANGE » menu "

### Display:

2<sup>nd</sup> line display:  
Control mode

```

T I M E T A B L E   N °   x           ↑
                                           ↓
  
```

N° of selected spacing,  
from 1 to 6

Unroll the time range with key + or – then validate with key "ENTER"

Once the time range has been selected, the regulation type has to be chosen.

By pressing "Enter", we have access to the setting. By pressing key + or – , the following menus appear.

For validation,press "Enter".

T Y P E O F C O N T R O L	↑
S E T P O I N T 1 - O F F	↓
T Y P E O F C O N T R O L	↑
S E T P O I N T 2 - O F F	↓
T Y P E O F C O N T R O L	↑
S E T P . 1 - S E T P . 2	↓
T Y P E O F C O N T R O L	↑
S E T P . 2 - S E T P . 1	↓
T Y P E O F C O N T R O L	↑
N O V A L I D	↓

Once the regulation has been validated, « days selected » appears

S E L E C T D A Y S	↑
M T W T F S S	↓

By pressing Enter, days are selected: key "+" to validate the day – key "-" to remove the validation.  
Set in this order the starting hour/starting minute/ending hour/ending minute.

S T A R T O F T I M E	Y Y H X X	↑
E N D O F T I M E	Y Y H X X	↓

By pressing "ENTER", set hours, then minutes.

Any modification leads to the updating of the unit status.

Any type of setting is possible (starting time < ending time, starting time = ending time, starting time > ending time)

If the ending time ≤ starting time, the programme is considered to be ending on the following day.

If one enters in the menu "HOLIDAY ZONES"

**Display:**

2<sup>nd</sup> line display:  
zone type

D A Y S O F F N ° X	↑
	↓

{ N° of zone selected,  
from 1 to 6

Select the n° of the holiday zone to be set by pressing "ENTER".

**Setting text:**

T Y P E O F Z O N E	↑
N O V A L I D	↓
T Y P E O F Z O N E	↑
S T O P	↓
T Y P E O F Z O N E	↑
S E T P O I N T 1	↓
T Y P E O F Z O N E	↑
S E T P O I N T 2	↓

Starting day and ending day

Set in the following order:

Starting day /starting month /ending day /ending month.

D A T E O F S T A R T	D D / M M	↑
D A T E O F E N D	D D / M M	↓

All types of settings are possible (starting day < ending day, starting day = ending day, starting day > ending day)

If the ending day < starting day, the programme is considered to be ending the year after.

**Operation of holiday zones:**

If a holiday zone is active (starting date ≤ present date ≤ ending date), **the time ranges become non active.**

The unit operating status becomes the one of the active zone (stop, running on setting 1 or running on setting 2).

At the end of the holiday zone, if no time zone is validated, the operation is the one existing at the start of the holiday zone



**Example:**

Prog 1: 7-12h STP1-STP2 MTW TF  
Prog 2: 10-18h STP1-stop MT TF

Holiday zone: 10-08 / 30-08 : stop

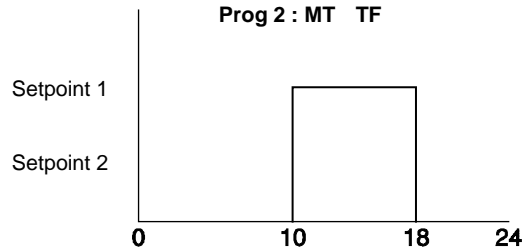
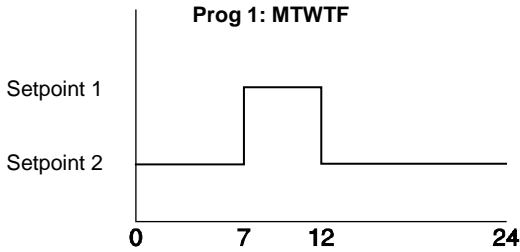

**Result:**

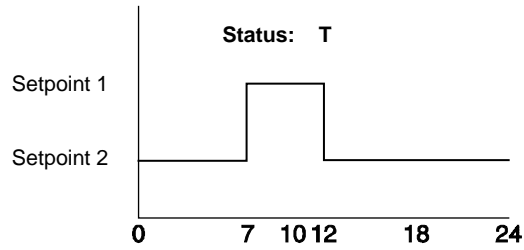
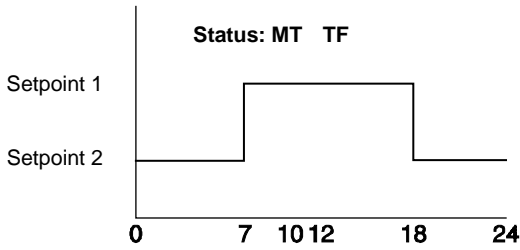

Saturday and Sunday not being selected in the hourly programming, the unit is therefore stopped.  
The unit is stopped between 10th August and 30th August, this period being selected as holiday zone.

**27 MANAGEMENT OF A REFRIGERANT FLUID LEAK AND LEAK FAULT DETECTOR:**

When the option is present on the machine, the P104 parameter allows the BUS connection with the CAREL leak detector(s) to become operational.

**P104 :**

Access level = 2

P 1 0 4   L E A K   D E T E C T I O N	N O
---------------------------------------	-----

Possible settings: YES; NO  
Default value = NO

- The P104.1 parameter delays the fault information gathered by the CAREL leak detector(s) from being taken into account

**P104.1 :**

Access level = 2  
Display if P 104 = Yes

P 1 0 4 . 1   L E A K   D E T E C T I O N
T I M E   D E L A Y   1 . 0   m i n

Possible settings: 0 to 5 minutes in increments of 30 seconds  
Default value = 1 min

**27.1 Link between the CAREL detector and the controller:**

The CAREL detector and the controller are linked through an RS 485 connection using the Modbus protocol by linking to the MOLEX terminal block available for the last additional card, apart from in the following cases:

- When only the energy management option is present, the connection should be made using the dedicated RS 485 connection on the DIRIS module.
- When only the variable speed pump option is present, the connection should be made using the dedicated RS 485 connector on the frequency inverter.

The detector unit should always be the last component in the loop; thus the last CAREL unit in the loop should be equipped with line termination resistance.

When a machine has two circuits, there will be two detectors linked in series inside the unit provided by CAREL; thus there will only be one connection between the unit and the regulator.

## 27.2 Management of faults when a leak is detected by the CAREL unit if P104 = YES:

In a machine with two circuits, the fault will be managed per circuit.

The fault is managed even when the machine is stopped.

The fault will be taken into account when the detector signals a P104 fault for 1 second.

- If a fault occurs:

Staged or forced stop of the compressors in the circuit concerned

Pump switched on even if "standby mode" is active

Add to the fault memory

Machine fault output on

General fault LED on console lit steady

Display:

```
M A C H I N E   O F F
C I R C U I T   X   L E A K   F A U L T
```

- **Resetting:**

RESET button.

- Message displayed in the fault memory

```
C I R C U I T   X   L E A K   F A U L T
```

## 27.3 Management of faults if communication (bus) with the CAREL unit is lost if P104 = YES:

If the connection between one of the two detectors and the controller is lost for 10 seconds or more, the following message will be displayed:

```
L I N K   F A U L T
C I R C U I T   X   D E T E C T O R
```

**If a fault occurs**

- No staged or forced stop of the compressors in the circuit concerned

- Circuit fault LED flashing

- Fault added to fault memory

- Fault relay stuck

- **Resetting:**

Automatic

- Message displayed in the fault memory

```
L I N K   C X   D E T E C T O R
```

## 27.4 Management of sensor faults in the CAREL detector if P104 = YES:

If a sensor fault occurs in the detector BUS connection, the following message will be displayed on the controller console:

```
S E N S O R   F A U L T
C I R C U I T   X   D E T E C T O R
```

**If a fault occurs**

- No staged or forced stop of the compressors in the circuit concerned

- Circuit fault LED flashing

- Fault added to fault memory

- Fault relay stuck

- **Resetting:**

Automatic

- Message displayed in the fault memory

```
C X   D E T E C T O R   S E N S O R
```

## 27.5 Reading parameters:

**P291 :**

- Information delivered by the CAREL detector

```
P 2 9 1           L E A K   D E T E C T E D
I N   C I R C U I T   1                               Y E S
```

**P291.1:**

- Information delivered by the CAREL detector

```

P 2 9 1 . 1           L E A K   D E T E C T E D
I N   C I R C U I T   2                               Y E S

```

**28 MANAGEMENT OF ELECTRICAL POWER:**

Electrical values are measured by means of an external module that is connected to a current transformer and exchanges data with the controller via bus connection.

When the option is present on the machine, the parameter P 15.1 allows the bus communication with the electrical value measurement module to become operational.

```

P 1 5 . 1           E L E C T R I C A L   V A L U E
M E A S U R E M E N T S                               N O

```

YES; NO

Default value = NO

The parameter P15.2 allows you to control the type of electrical network for the electrical value measurement module

```

P 1 5 . 2           N E T   E L E C T R I C A L
N E T W O R K   T Y P E           3 B L

```

Possible settings: 1BL, 2BL,3BL,3NBL,4BL and 4NBL

Default value = 3 BL

The parameter P 16 allows control of the primary current transformer (CT) rating.

Display if P 15.1 = Yes

```

P 1 6           P R I M A R Y   C T
R A T I N G           x x x x x A

```

Programmable between 5 to 1000 A in increments of 1 with 400 A as the default value

The parameter P 17 allows you to set the secondary current transformer (CT) rating.

Display if P 15.1 = Yes

```

P 1 7   S E C O N D A R Y   C T
R A T I N G           5 A

```

Can be set to 1 or 5, with 5 A as the default

The parameter P 117 enables access to the power input limit function and selection of its activation mode.

Display if P 15.1 = Yes

```

P 1 1 7   P O W E R   I N P U T
L I M I T A T I O N           N O

```

Possible settings: no, permanent, by on/off input and yes by bus.

Default value = NO

The by on/off input command takes place on terminal block J6, terminals 7-9 of the main board, in which case all other "load shedding" inputs will be inactive.

The parameter P 118.1 allows control of the value to be considered for load shedding on the power input.

Display if P 117 ≠ No

```

P 1 1 8 . 1           M A X I M U M   P O W E R
L E V E L           x x x x K W

```

Programmable between 15 to 400 kW in increments of 1 with 200 kW as the default value

**28.1 Management of load shedding on a power input threshold:**

This function aims to prevent the machine from exceeding the power input threshold set by P118.1, by turning off the control stages.

It is inactive or deactivated in the following cases:

During a defrosting cycle, when reducing the power to the setpoint, in case of an on/off command or automated command, if the neutral zone is entered (P119 = "Cooling/heating auto by outdoor temperature), in test mode, if there is no communication with the DIRIS module for 2 minutes.

## 28.2 Reading parameters:

```
P 2 7 3 . 1   S U P P L Y   V O L T .  
U 1 : x x x V   U 2 : x x x V   U 3 : x x x V
```

```
P 2 7 4 . 1   M A C H I N E  
A B S O R B E D   P           x x x . x A
```

```
P 2 7 6 . 1   E L E C   P O W E R  
C O N S U M E D           x x x x k W h
```

```
P 2 7 5 . 1   M A C H I N E  
A B S O R B E D           x x x x . x k W
```

```
P 2 9 3   P O W E R  
M O N I T O R I N G   A C T I V E   X X X
```

YES/NO depending on the power load shedding request, regardless of the activation mode.

### - Resetting P 276.1:

The value in parameter P276.1 displays the total electrical power consumed. The user has the option to reset this counter as follows:

Once the parameter is displayed, press the applicable button and the following message will appear:

```
P 2 7 6 . 1   E L E C   P O W E R  
C O N S U M E D           R E S E T
```

Once the message above to reset the counter is displayed, press the enable button and then press the escape button once the counter is reset to return to the reading parameter (now set at zero).

```
P 2 7 6 . 1   E L E C   P O W E R  
C O N S U M E D           0 0 0 0 k W h
```

## 28.3 Display in the Measured values and Machine status menus:

If P15.1 = YES, in addition to the usual measured values, the electrical values appear as follows:

```
U 1 : x x x V   U 2 :   x x x V   U 3 : x x x V  
T O T A L   C   I N P U T :           X X X . X A  
T O T A L   P   I N P U T :           X X X . X   k W
```

If load shedding is active in the Machine status menu, the following message will appear:

```
           L O A D   S H E D D I N G   O N  
A B S O R B E D   P O W E R
```

## 29 MANAGEMENT OF MAINTENANCE REMINDER DISPLAY:

- Maintenance messages can be viewed in the Machine status menu.

They are first displayed one after the other ahead of other types of messages, alongside arrows ↑↓ acknowledging that the FGAS message has priority.

- Once all the maintenance messages have been shown once, they are moved to the bottom of the Machine status menu behind other types of messages.

- All the maintenance parameters are regrouped in menu 17 which can be accessed from level 2

```
1 7 - M A I N T E N A N C E
```

## 29.1 FGAS tightness check reminder:

Parameter P 900 enables activation and regulation of the check frequency

P 9 0 0	F G A S	T I G H T N E S S	
C H E C K	R E M I N D E R		N O

Possible setting: no -03-06-12 months  
Default value = NO  
Visible irrespective of the type of machine.

The count begins when the function is activated  
The following message will appear in the Maintenance status menu:

F G A S	C H E C K	I N	X X	D
C A L L	S T E	M A I N T E N A N C E		

- The message is displayed:
- 15 days before the provisional date of the check (P900) every 3 months
- 21 days before the provisional date of the check (P900) every 6 or 12 months

The counter decreases each day from the date it was first displayed.

The reminder message will remain on the user interface of the unit until the maintenance operator acknowledges it with the following parameter:

The parameter P 901 allows the operator to reset the reminder counter

P 9 0 1	R E S E T	F G A S	
C H E C K			

Once the parameter is displayed, press the applicable button and the following message will appear:

P 9 0 1	R E S E T	F G A S	
C H E C K			O K

Visible if P900 ≠ No

Press the enable button to reset the counter, press ESCape once reset is enabled to exit, otherwise the counter will not be reset.  
This function will be activated by default ex works.

## 29.2 Maintenance reminder:

The "Maintenance reminder" function will be activated independently of the "FGAS tightness check" described above.

The parameter P 910 enables activation of the REMINDER function and regulation of its management mode

P 9 1 0	M A I N T E N A N C E	C H E C K	
R E M I N D E R			N O

Possible settings: no or hours or days or months  
Default value = NO  
Visible irrespective of the type of machine.

Parameter P 911 allows you to set the REMINDER frequency

### - For reminder (P 910) in hours

P 9 1 1	M A I N T E N A N C E	C H E C K	
F R E Q U E N C Y	x x x x	h o u r s	

Possible setting: 1 to 9999 hrs  
Default value = 2000 hrs

### - For reminder (P 910) in months

P 9 1 1	M A I N T E N A N C E	C H E C K	
F R E Q U E N C Y	x x	m o n t h s	

Possible setting: 1 to 99 months  
Default value = 12 months

The counter starts once the P 911 value is enabled

If the function is activated, the following message appears in the Maintenance status menu:

- For reminder (P 910) in months

```
M A I N T E N A N C E   I N   X X   D
C A L L   S T E   M A I N T E N A N C E
```

- For reminder (P 910) in hours

```
M A I N T E N A N C E   I N   X X X   h r s
C A L L   S T E   M A I N T E N A N C E
```

- The message is displayed:

- For reminder in months:

10 days before the provisional date of the check if  $P 912 < 3$  months  
20 days before the provisional date of the check if  $3 \leq P 912 < 6$  months  
20 days before the provisional date of the check if  $P 912 \geq 6$  months

- For reminder in hours:

150 hrs before the provisional date of the check if  $P 912 < 1000$  hrs.  
300 hrs before the provisional date of the check if  $1000 \text{ hrs} \leq P 912 < 2000$  hrs.  
300 hrs before the provisional date of the check if  $P 912 \geq 2000$  hrs.

The counter progresses every hour or month from the moment it was first displayed up to the scheduled date.

The reminder message remains on the user interface of the unit until the maintenance operator acknowledges it in the following manner:

The parameter P 912 allows the operator to reset the reminder counter

```
P 9 1 2   R E S E T   M A I N T E N A N C E
C H E C K
```

Once the parameter is displayed, press the enable button and the following message will appear:

```
P 9 1 2   R E S E T   M A I N T E N A N C E
C H E C K                               O K
```

- Visible if  $P910 \neq \text{No}$

Press the enable button to reset the counter, press ESCape once reset is enabled to exit, otherwise the counter will not be reset.

This function will not be activated ex works

### 29.3 Useful information for both functions:

When the count reaches the scheduled maintenance date, the general fault LED flashes and the fault relay is triggered until the counter is reset

If the count is in months, precision is specified in days.

In the event that the hour or date is changed after activating a reminder function, the one that was set at the time of activation is taken into account for starting the count. This means that if the set date is shifted towards the end date of the count, the count values will decrease (function test)

By contrast, if there is a large shift between the date and hour displayed by the controller and the real values, after being set, it is makes more sense to reset the counters for maintenance functions.

The data linked to the periodic maintenance checks described above is available on the controller bus (customer access bits), and can therefore return to the levels of BMS/CMS, apart from the counter resets.

The data will also return to supervision level.

## 30 COMMUNICATION PROTOCOL

### 1) Communication medium.

- RS485

3-pin connector on J11    terminal 1:    A or +  
                                 terminal 2:    B or –  
                                 terminal 3:    connected to earth for    shielding if desired

Two lights provide information on the status of the transmission (see Section 3.1, control board)

- D50 → Receive LED. Usually off; flashes when a message is received by the board.

If this light remains on, the bus is reversed. Swap terminals 1 and 2 on J11.

- D52 → Send LED. Usually off; lights up when the CPU sends a message over the bus.

#### Transmission mode.

#### Serial, asynchronous, half duplex, RTU mode.

- 1 start bit,
- 8 data bits,
- The parity is set via parameter P702,
- The number of stop bits is set via parameter P703,
- The transmission speed is set via parameter P701,
- The unit number on the bus is set via parameter P705.

#### Coding of analogue values

Standard 32-bit IEEE format (2 registers).

Order of values:

- If P704 = No → low order, high order.

- Si P704 = Yes → high order, low order.

Note: the write functions are enabled if parameter P706 is set to "Remote, CMS..."

#### Function codes used.

- 1 or 2: read n bits
- 3 or 4: read multiple registers (16 bits)
- 5: write one bit .....
- 6: write register function.....
- 8: read diagnostics counters
- 11: read event counter
- 15: write n bits
- 16: write multiple registers (16 bits)

**Note:** the write functions are enabled if parameter P103 is set to "Remote, BMS..."

#### Error codes:

- 1: function code unknown
- 2: address incorrect
- 3: data error

### 2 - Transmission mode via Ethernet

#### ● RJ45,

**Very important:** 1 single simultaneous Ethernet connection is supported.

In all cases, the link between the controller and the CMS functions via a crossover cable. Use of a straight cable depends on the CMS material

- The IP address is set via parameter P711
- The sub-net mask is set via parameter P712
- The port address is set via parameter P713

#### ● Coding of analogue values.

Standard 32-bit IEEE format (2 registers).

Order of values:

- If P714 = NO → low order, high order

- Si P714 = Yes → high order, low order

**Note:** the write functions are enabled if parameter P715 is set to "Remote, CMS..."

### 3 - Supported functions

#### ● Function codes used.

- 1 or 2: read n bits
- 3 or 4: read multiple registers (16 bits)
- 5: write one bit function.....
- 6: write register function.....
- 8:
- 11:
- 15: write n bits function
- 16: write multiple registers (16 bits) function

**Note:** the write functions are enabled if parameter P103 is set to "Remote, BMS..."

#### ● Error codes:

- 1: function code unknown
- 2: address incorrect
- 3: data error

### 30.1 Registers accessible by customer

Register No. hexadecimal	Register No. decimal	Description	Format	Type	
<b>Registers accessible in read-only mode (Functions 3 or 4)</b>					
0x01	1	Controller name	Decimal	Read-only	33 = Chiller/heat pump controller
0x02	2	Actual operating mode	Decimal	Read-only	
0x3 and 0x4	3 and 4	Outdoor temperature	Float	Read-only	
0x5 and 0x6	5 and 6	Control setpoint	Float	Read-only	
0x7 and 0x8	7 and 8	Evaporator inlet temperature	Float	Read-only	
0x9 and 0xa	9 and 10	Evaporator outlet temperature	Float	Read-only	
0xb and 0xc	11 and 12	Condenser temperature	Float	Read-only	
0x13	19	Number of stages on	Char	Read-only	Available with versions 09.00 and higher
0x20 and 0x21	32 and 33	P285 Heating mode runtime (in hours)	Float	Read-only	
0x22 and 0x23	34 and 35	P286 Cooling mode runtime (in hours)	Float	Read-only	
0x24 and 0x25	36 and 37	P287 Pump 1 runtime (in hours)	Float	Read-only	
0x26 and 0x27	38 and 39	P288 Pump 2 runtime (in hours)	Float	Read-only	
0x28 and 0x29	40 and 41	P310 Number of starts, stage 1, circuit 1	Float	Read-only	
0x2a and 0x2b	42 and 43	P311 Stage 1, circuit 1 runtime	Float	Read-only	
0x2c and 0x2d	44 and 45	P313 Number of starts, stage 2, circuit 1	Float	Read-only	
0x2e and 0x2f	46 and 47	P314 Stage 2, circuit 1 runtime	Float	Read-only	
0x30 and 0x31	48 and 49	P340 Number of starts, stage 1, circuit 2	Float	Read-only	
0x32 and 0x33	50 and 51	P341 Stage 1, circuit 2 runtime	Float	Read-only	
0x34 and 0x35	52 and 53	P343 Number of starts, stage 2, circuit 2	Float	Read-only	
0x36 and 0x37	54 and 55	P344 Stage 2, circuit 2 runtime	Float	Read-only	
0x50 and 0x51	80 and 81	Voltage between phase 1 and 2	Float	Read-only	V
0x52 and 0x53	82 and 83	Voltage between phase 2 and 3	Float	Read-only	V
0x54 and 0x55	84 and 85	Voltage between phase 1 and 3	Float	Read-only	V
0x68 and 0x69	104 and 105	Input current	Float	Read-only	A
0x6a and 0x6b	106 and 107	Instantaneous power consumption	Float	Read-only	kW
0x6c and 0x6d	108 and 109	Electrical power consumed	Float	Read-only	kWh
0x6e	110	No. of days before F gas tightness check	Decimal	Read-only	
0x6f	111	No. of days or hours before maintenance	Decimal	Read-only	
<b>Registers accessible in read mode (Functions 3 or 4) and write mode (Function 16)</b>					
0x101 and 0x102	257 and 258	P121 Cooling setpoint 1	Float	Read/Write	
0x103 and 0x104	259 and 260	P122 Cooling setpoint 2	Float	Read/Write	
0x105 and 0x106	261 and 262	P123 Heating setpoint 1	Float	Read/Write	
0x107 and 0x108	263 and 264	P124 Heating setpoint 2	Float	Read/Write	
0x109 and 0x10a	265 and 266	P125.1 Setpoint for 4 mA in cooling mode	Float	Read/Write	
0x10b and 0x10c	267 and 268	P125.2 Setpoint for 4 mA in heating mode	Float	Read/Write	
0x10d and 0x10e	269 and 270	P126.1 Setpoint for 20 mA in cooling mode	Float	Read/Write	
0x10f and 0x110	271 and 272	P126.2 Setpoint for 20 mA in heating mode	Float	Read/Write	
0x116	278	P910 Maintenance check reminder	Decimal	Read/Write	
0x117	279	P911 Maintenance check frequency	Usi	Read/Write	Hours if P910 is in hours Months if P910 is in months
<b>Registers accessible in read mode (Functions 3 or 4) and write mode (Functions 6 or 16)</b>					
0x200	512	Year	Decimal	Read/Write	0 to 99
0x201	513	Month	Decimal	Read/Write	1 to 12
0x202	514	Day of the month	Decimal	Read/Write	1 to 31
0x203	515	Day of the week	Decimal	Read/Write	1 to 7 (1: Monday, 2: Tuesday, etc.)
0x204	516	Hour	Decimal	Read/Write	0 to 23
0x205	517	Minutes	Decimal	Read/Write	0 to 59



## 30.2 Customer access bits

Hexadecimal bit No.	Bit No. decimal	Description	Type	
<b>Read-only bit (functions 1 or 2)</b>				
0x01	1	P103 Control type	Read-only	0: Local, 1: Remote
0x02	2	Operating summary (On/Off and automatic operation input closed)	Read-only	1 = On
0x03	3	State of pump 1 output	Read-only	1 = On
0x04	4	State of pump 2 output	Read-only	1 = On
0x05	5	Output state, stage 1, circuit 1	Read-only	1 = on
0x06	6	Output state, stage 2, circuit 1	Read-only	1 = On
0x07	7	Output state, stage 1, circuit 2	Read-only	1 = On
0x08	8	Output state, stage 2, circuit 2	Read-only	1 = On
0x09	9	State of auxiliary electric heater 1 or boiler	Read-only	1 = On
0x0a	10	State of auxiliary electric heater 2	Read-only	1 = On
0x0b	11	State of auxiliary electric heater 3	Read-only	1 = On
0x0c	12	State of auxiliary electric heater 4	Read-only	1 = On
0x0d to 0x0f reserved				
0x10	16	General fault summary (1 fault below present)	Read-only	1 = Fault
0x11	17	Phase controller fault	Read-only	1 = Fault
0x12	18	Water flow fault	Read-only	1 = Fault
0x13	19	Pump 1 fault		
0x14	20	Pump 2 fault	Read-only	1 = Fault
0x15	21	Pump fault, 1 loop	Read-only	1 = Fault
0x16	22	Pump fault, 2 loops	Read-only	1 = Fault
0x17	23	Heat exchanger inlet sensor fault	Read-only	1 = Fault
0x18	24	Heat exchanger outlet sensor fault	Read-only	1 = Fault
0x19	25	Outdoor temperature sensor fault	Read-only	1 = Fault
0x1a	26	Condenser sensor fault	Read-only	1 = Fault
0x1b	27	Manifold outlet sensor fault	Read-only	1 = Fault
0x1c	28	Fan fault	Read-only	1 = Fault
0x1d	29	EEPROM FAULT	Read-only	1 = Fault
0x1e	30	Inlet loop fault sensor ( <b>MULTI CHILLER/HEAT PUMP controller</b> )	Read-only	1 = Fault
0x1f	31	Outlet loop fault sensor ( <b>MULTI CHILLER/HEAT PUMP controller</b> )	Read-only	1 = Fault
0x20	32	AÉRO controller link fault	Read-only	1 = Fault
0x21	33	Outdoor temperature too high in cooling mode	Read-only	1 = Fault
0x22	34	Change of operating mode fault	Read-only	1 = Fault
0x23	35	Winter protection	Read-only	1 = Fault
0x24	36	Exchanger ambient sensor fault	Read-only	1 = Fault
0x25 to 0x3f reserved				
0x40	64	Circuit 1 fault summary	Read-only	1 = Fault
0x41	65	Stage 1, circuit 1 fault	Read-only	1 = Fault
0x42	66	Stage 2, circuit 1 fault	Read-only	1 = Fault
0x43	67	Manual HP fault, circuit 1	Read-only	1 = Fault
0x44	68	HP fault, circuit 1 pressure sensor	Read-only	1 = Fault
0x45	69	Circuit 1 LP fault	Read-only	1 = Fault
0x46	70	Water frosting fault, circuit 1	Read-only	1 = Fault
0x47	71	Refrigerant frosting fault, circuit 1	Read-only	1 = Fault
0x48	72	Exchanger frosting fault, circuit 1	Read-only	1 = Fault
0x49	73	Discharge fault, stage 1, circuit 1	Read-only	1 = Fault
0x4a	74	Discharge fault, stage 2, circuit 1	Read-only	1 = Fault
0x4b	75	Defrosting fault, circuit 1	Read-only	1 = Fault
0x4c	76	Expansion valve fault, circuit 1	Read-only	1 = Fault
0x4d	77	Stepper motor fault, circuit 1 expansion valve	Read-only	1 = Fault
0x4e	78	Low superheat fault, circuit 1	Read-only	1 = Fault
0x4f	79	High superheat fault, circuit 1	Read-only	1 = Fault
0x50	80	VCM module fault, expansion valve 1	Read-only	1 = Fault
0x51	81	Exchanger outlet sensor fault, circuit 1	Read-only	1 = Fault

Hexadecimal bit No.	Bit No. decimal	Description	Type	
0x52	82	Exchanger freon sensor fault, circuit 1	Read-only	1 = Fault
0x53	83	Sensor fault, coil A, circuit 1	Read-only	1 = Fault
0x54	84	Sensor fault, coil B, circuit 1	Read-only	1 = Fault
0x55	85	Sensor fault, coil C, circuit 1	Read-only	1 = Fault
0x56	86	Sensor fault, coil D, circuit 1	Read-only	1 = Fault
0x57	87	Discharge sensor fault, stage 1, circuit 1	Read-only	1 = Fault
0x58	88	Discharge sensor fault, stage 2, circuit 1	Read-only	1 = Fault
0x59	89	Circuit 1 HP sensor fault	Read-only	1 = Fault
0x5a	90	Circuit 1 LP sensor fault	Read-only	1 = Fault
0x5b	91	Circuit 1 suction sensor fault	Read-only	1 = Fault
0x5c	92	Circuit 1 liquid sensor fault	Read-only	1 = Fault
0x5d	93	Circuit 1 exp. valve board link fault	Read-only	1 = Fault
0x5e	94	Link fault, additional board for reversible	Read-only	1 = Fault
0x5f	95	Tsat discharge fault, Inverter compressor	Read-only	1 = Fault
0x60	96	Mechanical fault, Inverter compressor	Read-only	1 = Fault
0x61 to 0x7f reserved				
0x80	128	Load shedding, stage 1, circuit 1	Read-only	1 = Load shedding
0x81	129	Load shedding, stage 2, circuit 1	Read-only	1 = Load shedding
0x82 to 0x9f reserved				
0x100	256	Circuit 2 fault summary	Read-only	1 = Fault
0x101	257	Stage 1, circuit 2 fault	Read-only	1 = Fault
0x102	258	Stage 2, circuit 2 fault	Read-only	1 = Fault
0x103	259	Manual HP fault, circuit 2	Read-only	1 = Fault
0x104	260	HP fault, circuit 2 pressure sensor	Read-only	1 = Fault
0x105	261	Circuit 2 LP fault	Read-only	1 = Fault
0x106	262	Water frosting fault, circuit 2	Read-only	1 = Fault
0x107	263	Refrigerant frosting fault, circuit 2	Read-only	1 = Fault
0x108	264	Exchanger frosting fault, circuit 2	Read-only	1 = Fault
0x109	265	Discharge fault, stage 1, circuit 2	Read-only	1 = Fault
0x10a	266	Discharge fault, stage 2, circuit 2	Read-only	1 = Fault
0x10b	267	Defrosting fault, circuit 2	Read-only	1 = Fault
0x10c	268	Expansion valve fault, circuit 2	Read-only	1 = Fault
0x10d	269	Stepper motor fault, circuit 2 expansion valve	Read-only	1 = Fault
0x10e	270	Low superheat fault, circuit 2	Read-only	1 = Fault
0x10f	271	High superheat fault, circuit 2	Read-only	1 = Fault
0x110	272	VCM module fault, expansion valve 2	Read-only	1 = Fault
0x111	273	Exchanger outlet sensor fault, circuit 2	Read-only	1 = Fault
0x112	274	Exchanger freon sensor fault, circuit 2	Read-only	1 = Fault
0x113	275	Sensor fault, coil A, circuit 2	Read-only	1 = Fault
0x114	276	Sensor fault, coil B, circuit 2	Read-only	1 = Fault
0x115	277	Sensor fault, coil C, circuit 2	Read-only	1 = Fault
0x116	278	Sensor fault, coil D, circuit 2	Read-only	1 = Fault
0x117	279	Stage 1, circuit 2 discharge sensor fault	Read-only	1 = Fault
0x118	280	Stage 2, circuit 2 discharge sensor fault	Read-only	1 = Fault
0x119	281	Circuit 2 HP sensor fault	Read-only	1 = Fault
0x11a	282	Circuit 2 LP sensor fault	Read-only	1 = Fault
0x11b	283	Circuit 2 suction sensor fault	Read-only	1 = Fault
0x11c	284	Circuit 2 liquid sensor fault	Read-only	1 = Fault
0x11d	285	Circuit 2 exp. valve board link fault	Read-only	1 = Fault
0x11e	286	Link fault, additional board for reversible	Read-only	1 = Fault
0x11f to 0x13f reserved				
0x140	320	Load shedding, stage 1, circuit 2	Read-only	1 = Load shedding
0x141	321	Load shedding, stage 2, circuit 2	Read-only	1 = Load shedding
0x142	322	Fgas maintenance to be performed	Read-only	1 = Maintenance required
0x143	323	Fgas maintenance fault	Read-only	1 = Fault
0x144	324	Maintenance to be performed	Read-only	1 = Maintenance required
0x145	325	Maintenance fault	Read-only	1 = Fault

Hexadecimal bit No.	Bit No. decimal	Description	Type	
<b>Read (Functions 1 or 2) and write (Functions 5 or 15) bit</b>				
0x200	512	On/Off	Read/Write	1 = On
0x201	513	Control set to setpoint 1 or 2	Read/Write	1 = Control set to setpoint 2
0x202	514	Heating or cooling operation	Read/Write	1 = Heating
0x203	515	Load shedding via Modbus, stage 1, circuit 1 (different from 0 x 140)	Read/Write	1 = Off
0x204	516	Load shedding via Modbus, stage 2, circuit 1	Read/Write	1 = Off
0x205	517	Load shedding via Modbus, stage 1, circuit 2	Read/Write	1 = Off
0x206	518	Load shedding via Modbus, stage 2, circuit 2	Read/Write	1 = Off
<b>Read bit (Functions 1 or 2) → Available with versions 09.00 and higher</b>				
0x220	544	On/Off summary (1 = keypad on/off = 1 and all automatic operation controls closed and no oil warm-up time and no faults)	Read-only	
0x221	545	1 = Cooling possible	Read-only	
0x222	546	1 = Heating possible	Read-only	
0x223	547	1 = 1 stage on	Read-only	
0x224	548	1 = Maximum available power reached	Read-only	
0x225	549	1 = A major fault preventing output has occurred	Read-only	
0x226	550	1 = A reset fault has occurred but output is possible	Read-only	
0x227	551	1 = A fault requiring servicing has occurred	Read-only	



Order No.: 10150-00, 07.2016 - Supersedes order No.: New  
Manufacturer reserves the right to change any product specifications without notice.

Manufactured for CARRIER in France  
Printed in the European Union.